

V
THE VALLEY

EDEN

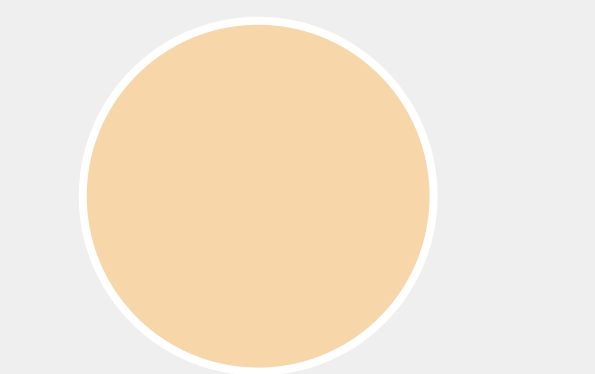

SPRUCE

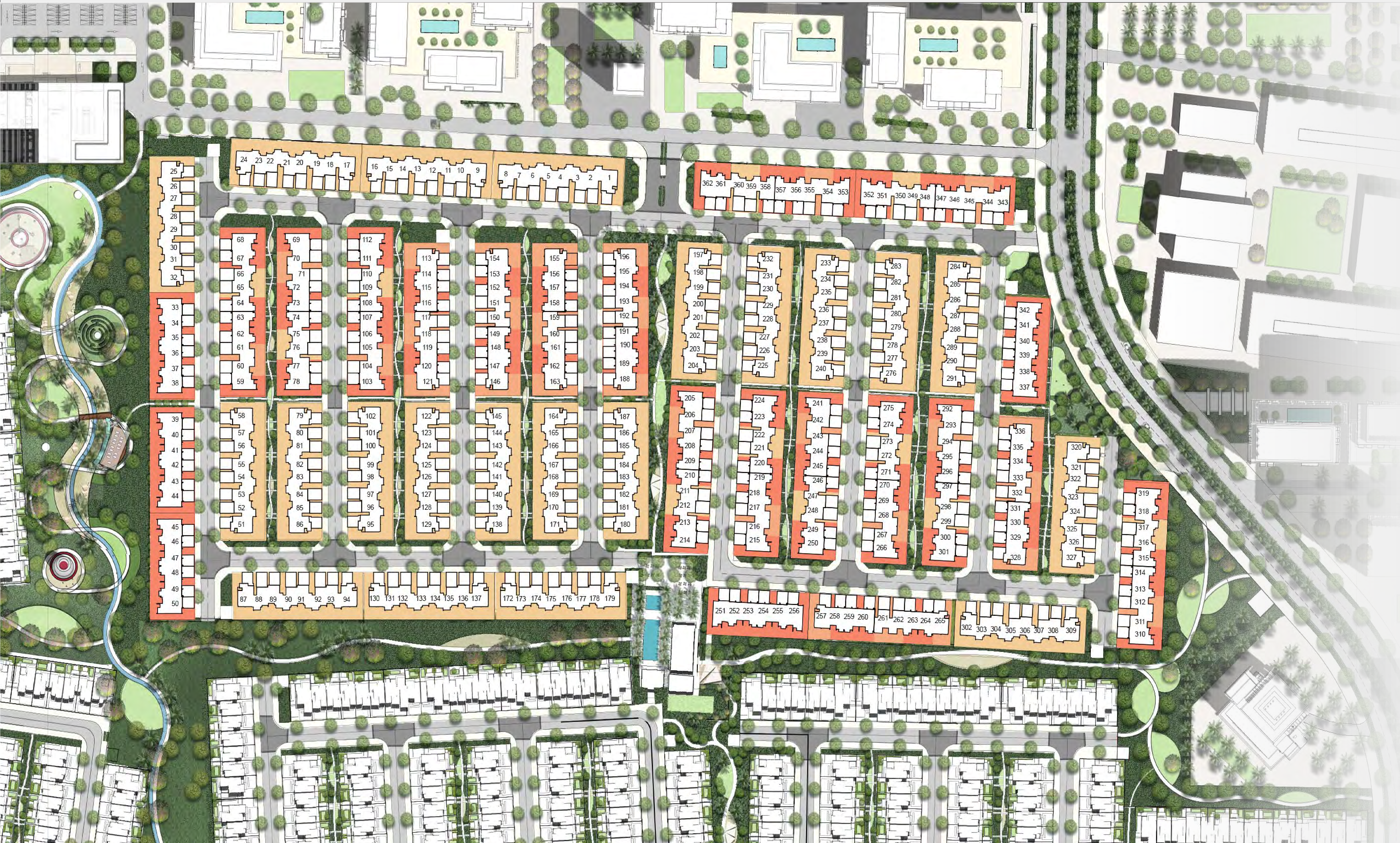
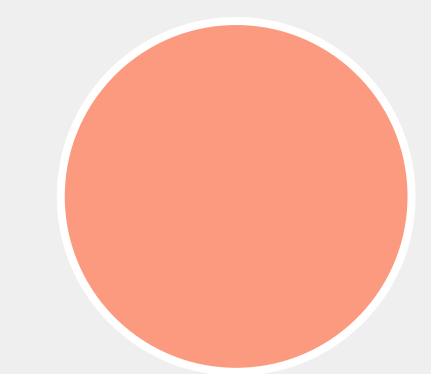

IRIS

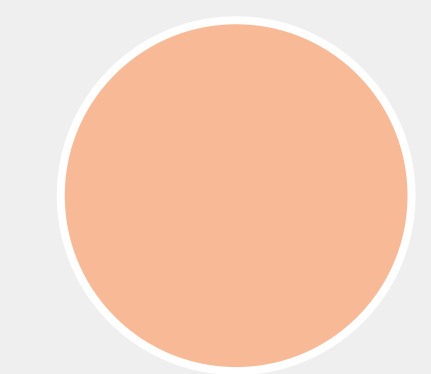

MAY BELL

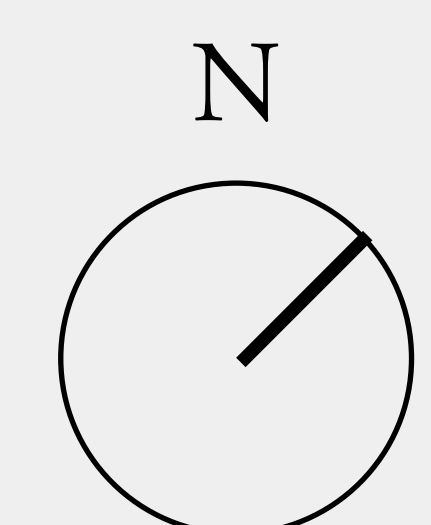

FLOOR PLAN 1. All dimensions are in imperial and metric, and measured from finish to finish excluding construction tolerances. 2. All materials, dimensions, and drawings are approximate only. 3. Information is subject to change without notice, at developer's absolute discretion. 4. Actual area may vary from the stated area. 5. Drawings not to scale. 6. All images used are for illustrative purposes only and do not represent the actual size, features, specifications, fittings, and furnishings. 7. The developer reserves the right to make revisions / alterations, at it's absolute discretion, without any liability whatsoever.

V
THE VALLEY

EDEN

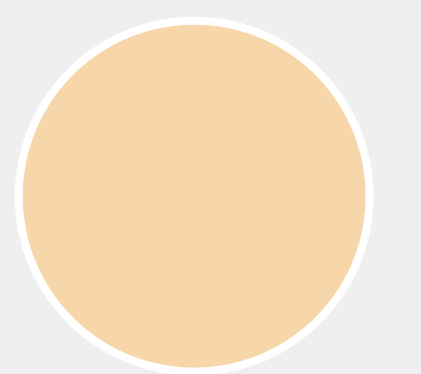

SPRUCE

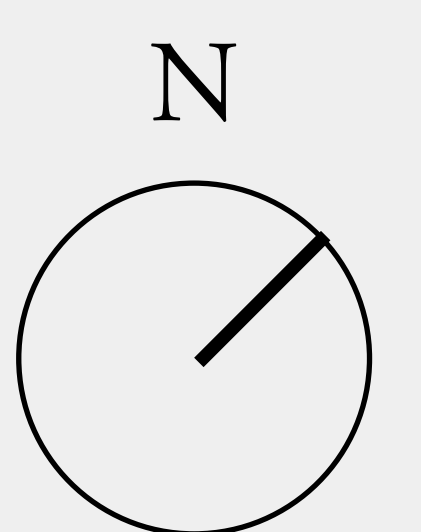

FLOOR PLAN 1. All dimensions are in imperial and metric, and measured from finish to finish excluding construction tolerances. 2. All materials, dimensions, and drawings are approximate only. 3. Information is subject to change without notice, at developer's absolute discretion. 4. Actual area may vary from the stated area. 5. Drawings not to scale. 6. All images used are for illustrative purposes only and do not represent the actual size, features, specifications, fittings, and furnishings. 7. The developer reserves the right to make revisions / alterations, at it's absolute discretion, without any liability whatsoever.

THE VALLEY

EDEN

SPRUCE 3 BEDROOM 1 A

UNIT	TOTAL AREA	
8 PLEX - TH 02	1937.39 SQFT	179.99 SQM
8 PLEX - TH 04	1929.75 SQFT	179.28 SQM
8 PLEX - TH 06	1929.75 SQFT	179.28 SQM

KEY PLAN

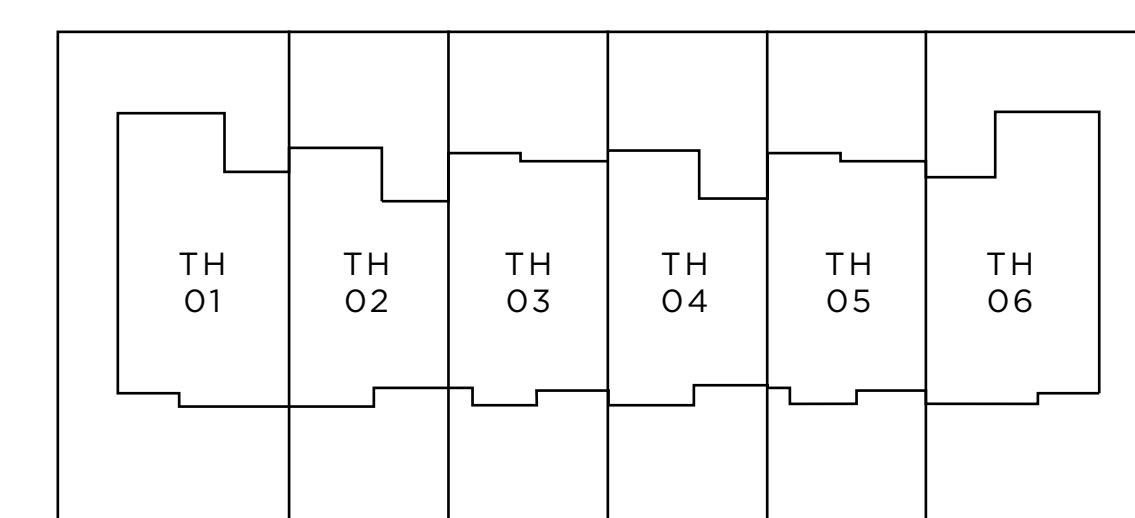

6 PLEX
STREET SIDE

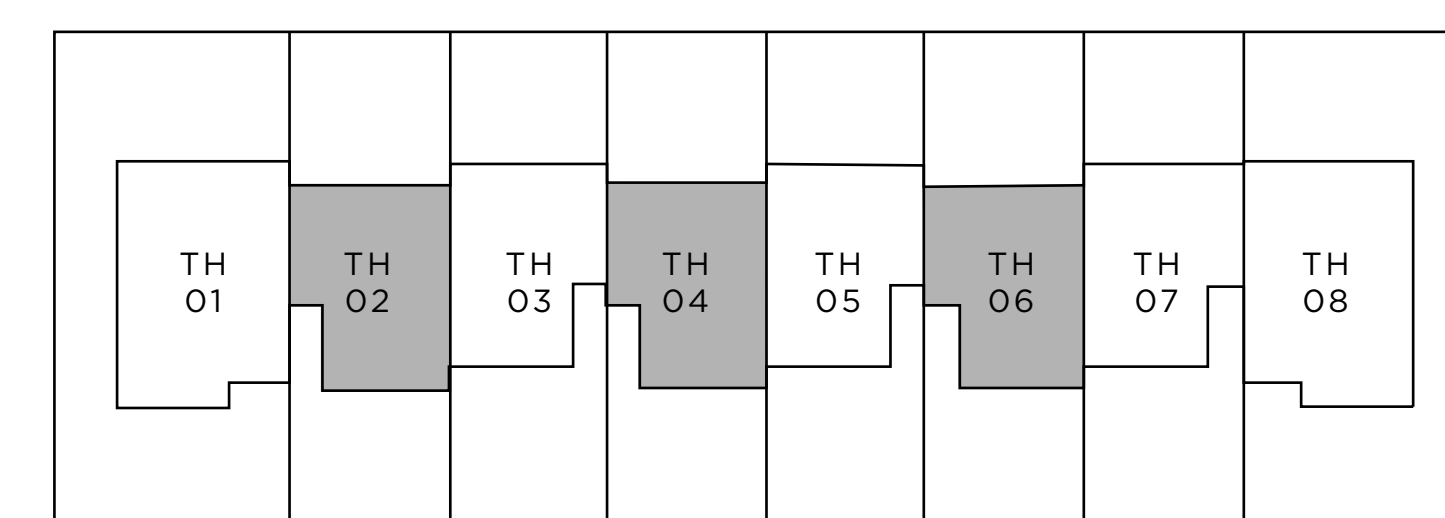

8 PLEX
STREET SIDE

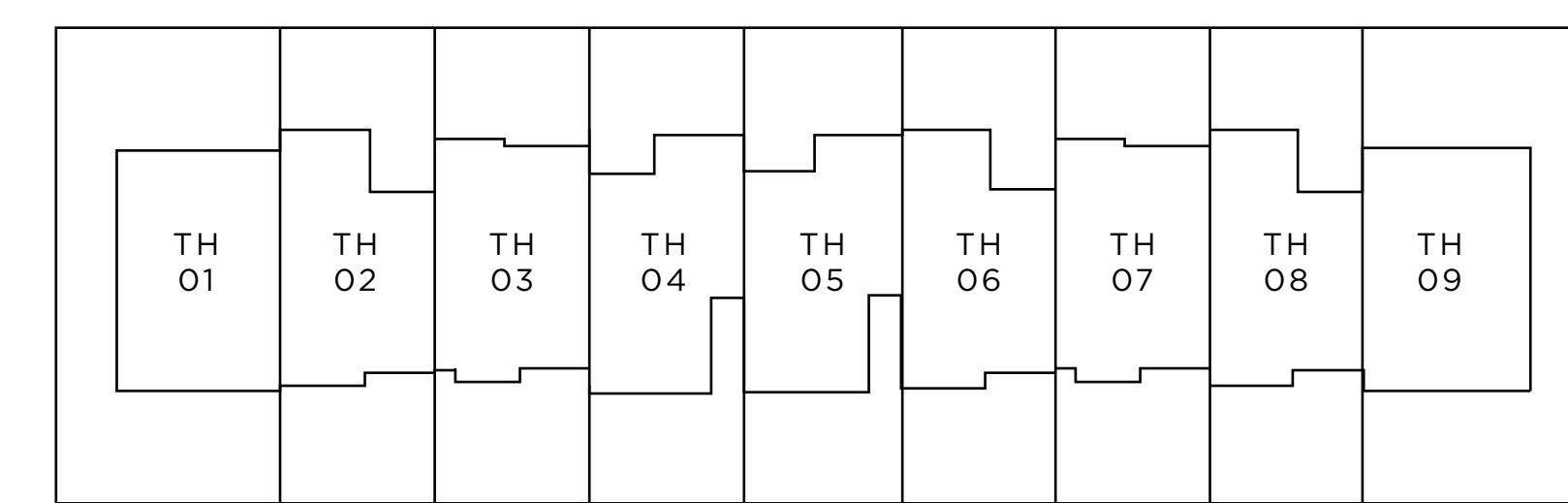

9 PLEX
STREET SIDE

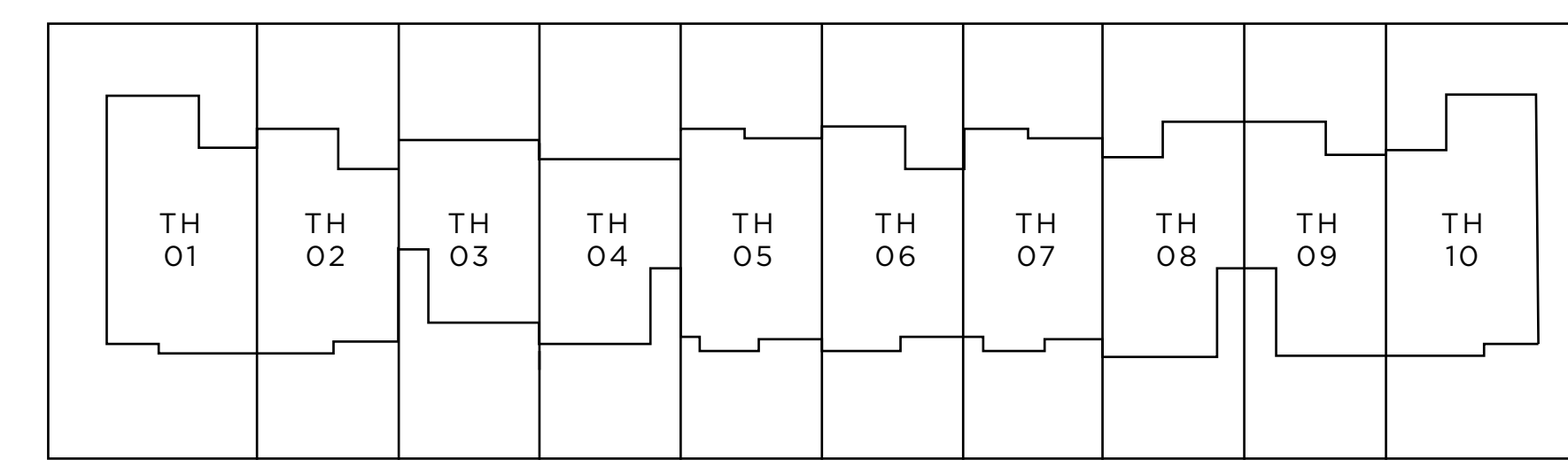

10 PLEX
STREET SIDE

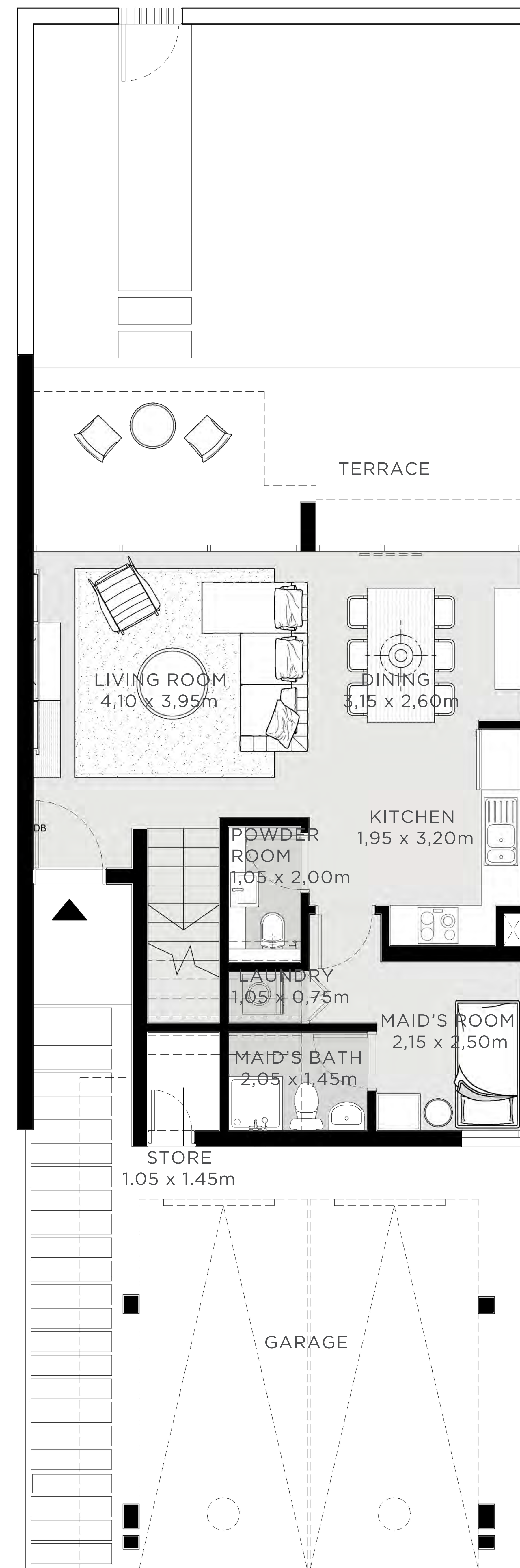

GROUND FLOOR

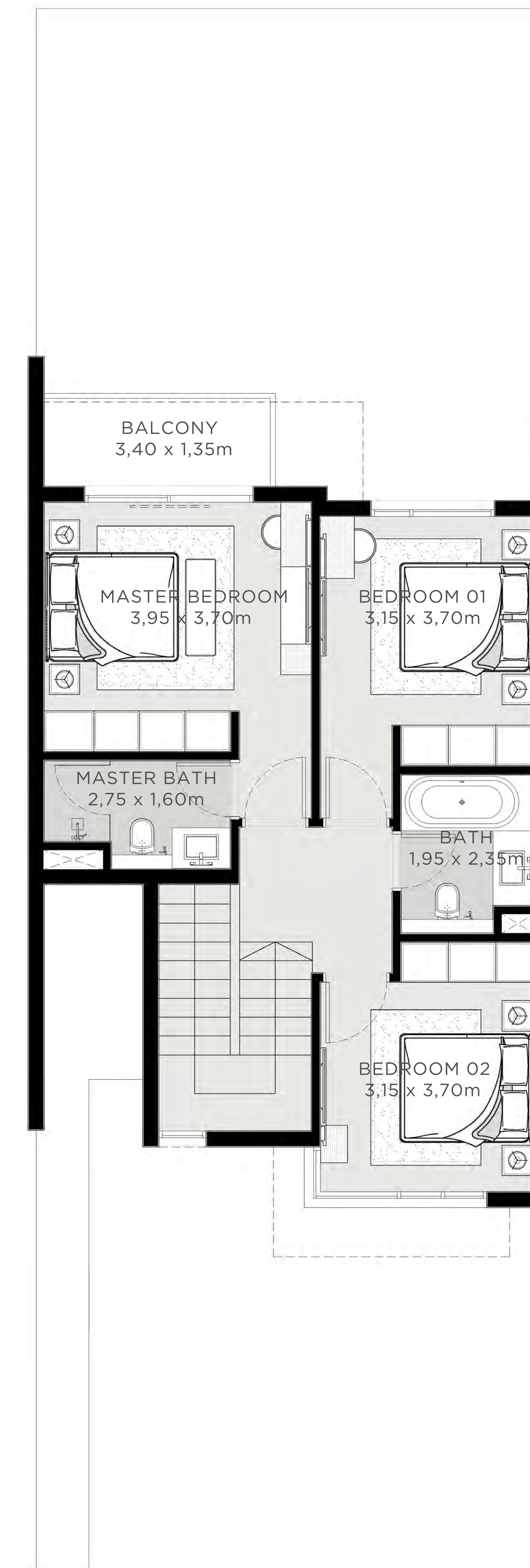

FIRST FLOOR

FLOOR PLAN 1. All dimensions are in imperial and metric, and measured from finish to finish excluding construction tolerances. 2. All materials, dimensions, and drawings are approximate only. 3. Information is subject to change without notice, at developer's absolute discretion. 4. Actual area may vary from the stated area. 5. Drawings not to scale. 6. All images used are for illustrative purposes only and do not represent the actual size, features, specifications, fittings, and furnishings. 7. The developer reserves the right to make revisions / alterations, at it's absolute discretion, without any liability whatsoever.

THE VALLEY

EDEN

SPRUCE 3 BEDROOM I B

UNIT	TOTAL AREA	
8 PLEX - TH 03	1988.41 SQFT	184.73 SQM
8 PLEX - TH 05	1988.41 SQFT	184.73 SQM
8 PLEX - TH 07	1996.81 SQFT	185.51 SQM

KEY PLAN

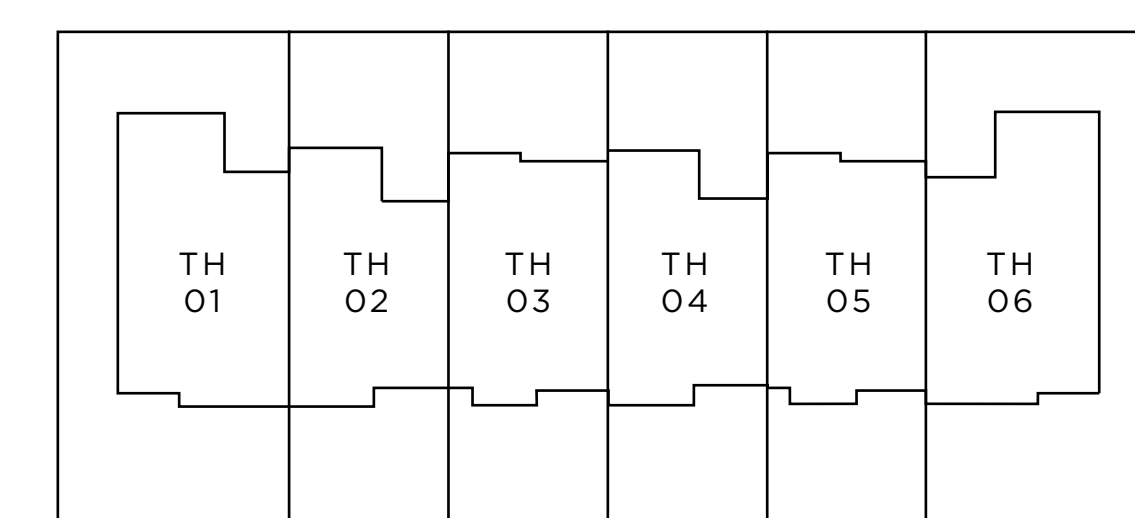

6 PLEX
STREET SIDE

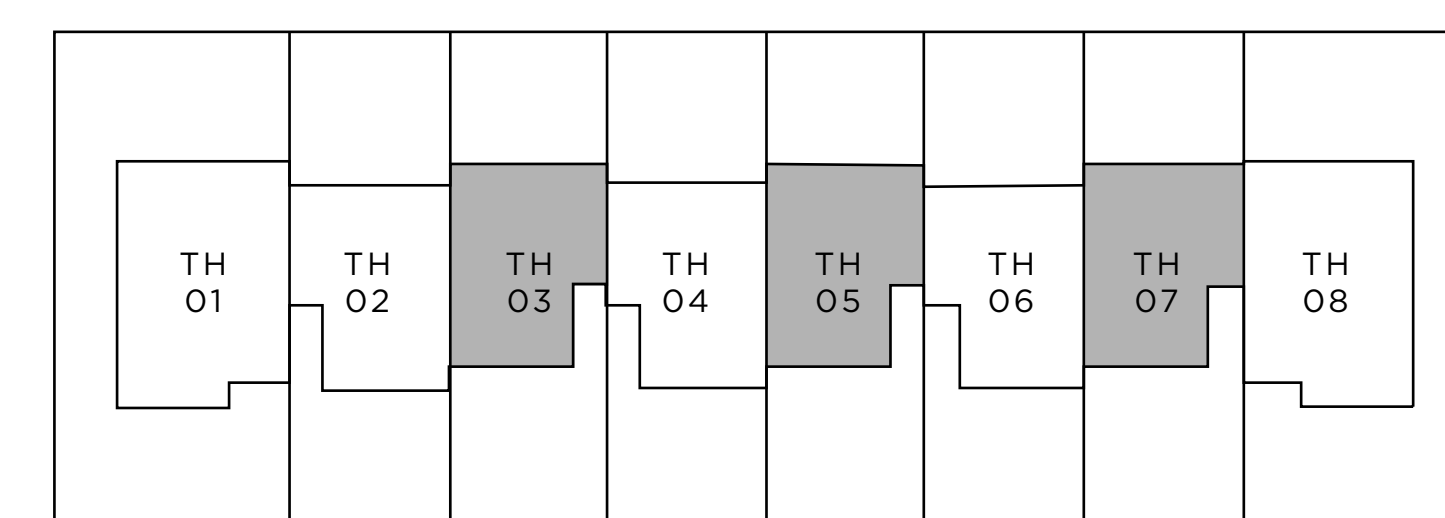

8 PLEX
STREET SIDE

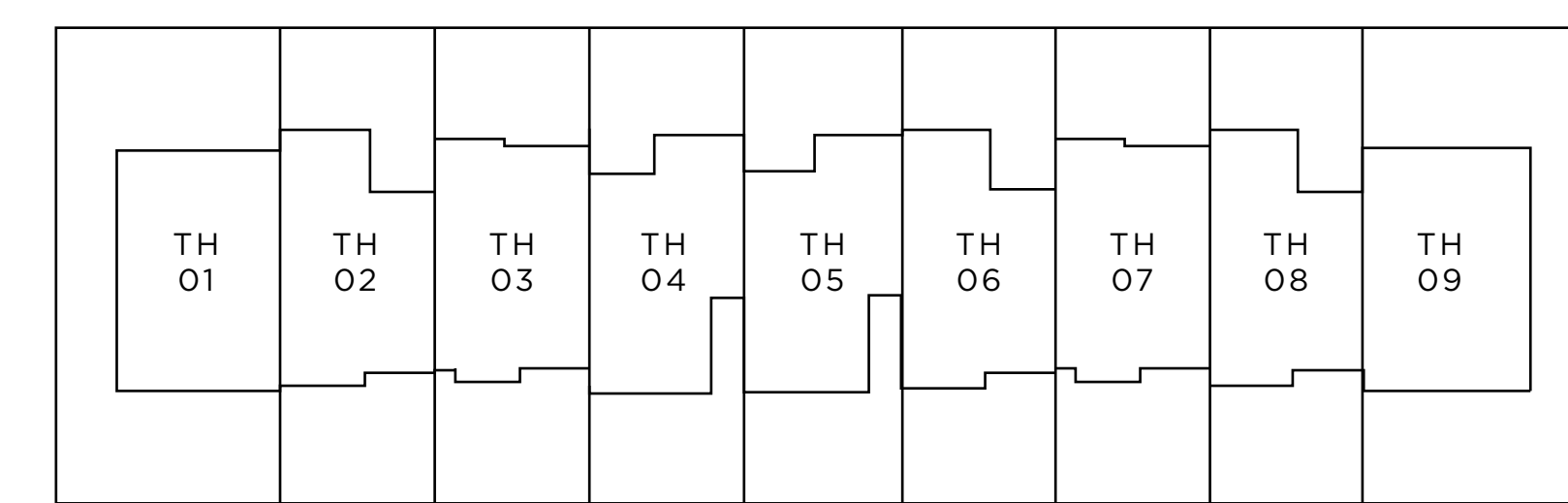

9 PLEX
STREET SIDE

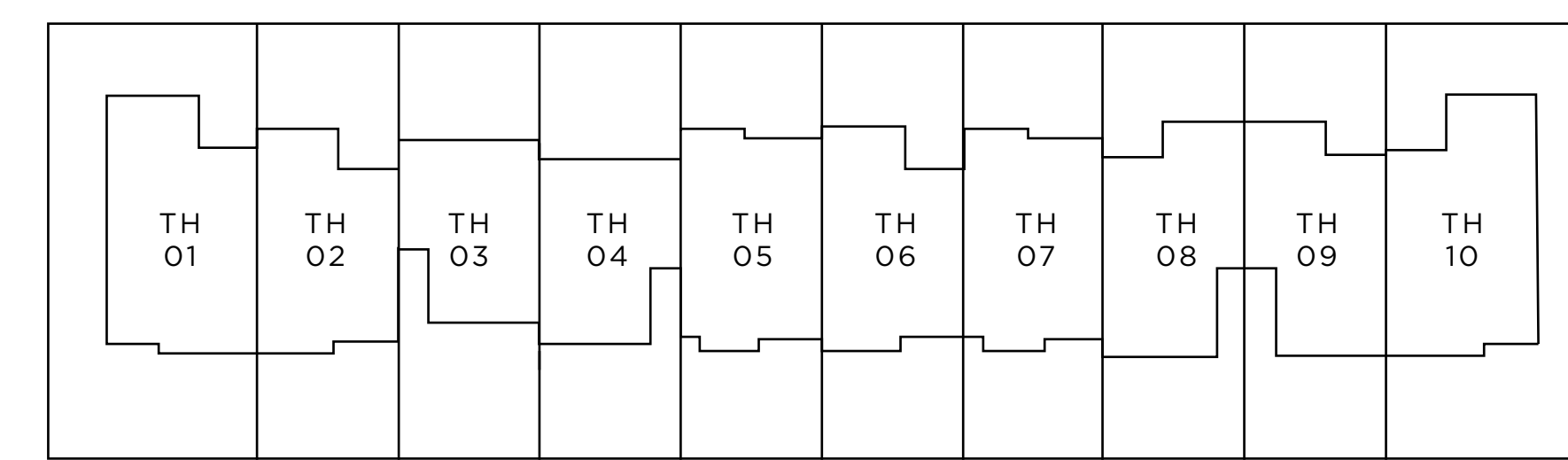

10 PLEX
STREET SIDE



GROUND FLOOR

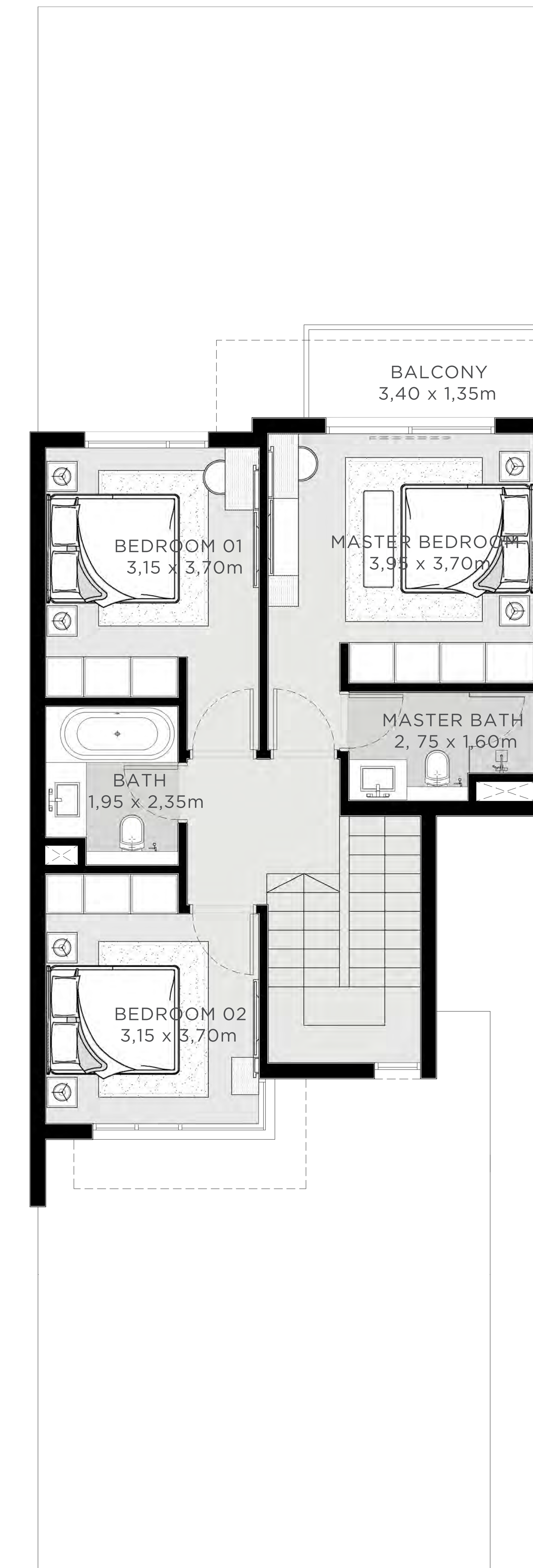

FIRST FLOOR

FLOOR PLAN 1. All dimensions are in imperial and metric, and measured from finish to finish excluding construction tolerances. 2. All materials, dimensions, and drawings are approximate only. 3. Information is subject to change without notice, at developer's absolute discretion. 4. Actual area may vary from the stated area. 5. Drawings not to scale. 6. All images used are for illustrative purposes only and do not represent the actual size, features, specifications, fittings, and furnishings. 7. The developer reserves the right to make revisions / alterations, at it's absolute discretion, without any liability whatsoever.

THE VALLEY

EDEN

SPRUCE
3 BEDROOM I C

UNIT	TOTAL AREA	
10 PLEX - TH 03	2038.68	189.40 SQM

KEY PLAN

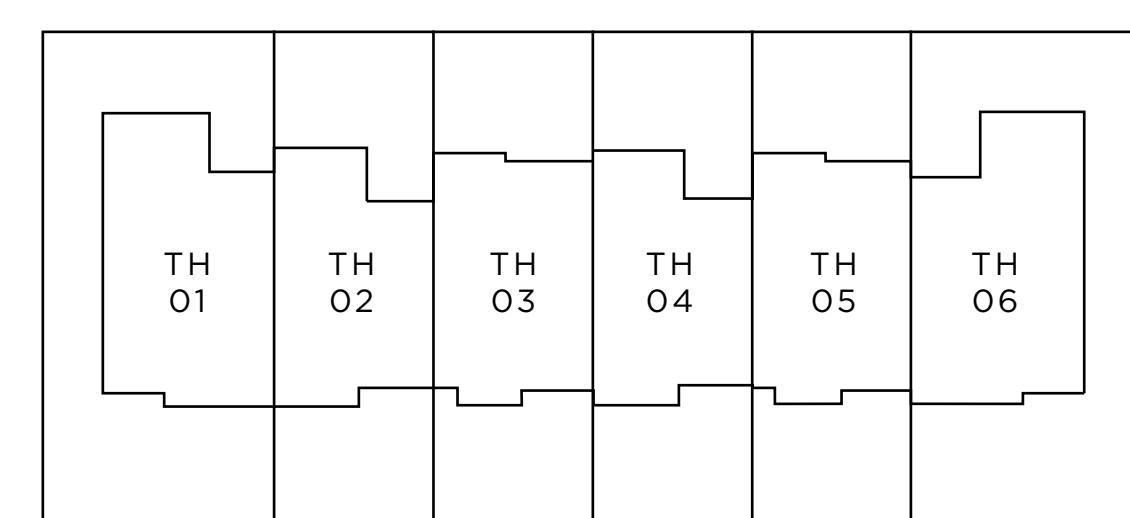

6 PLEX
STREET SIDE

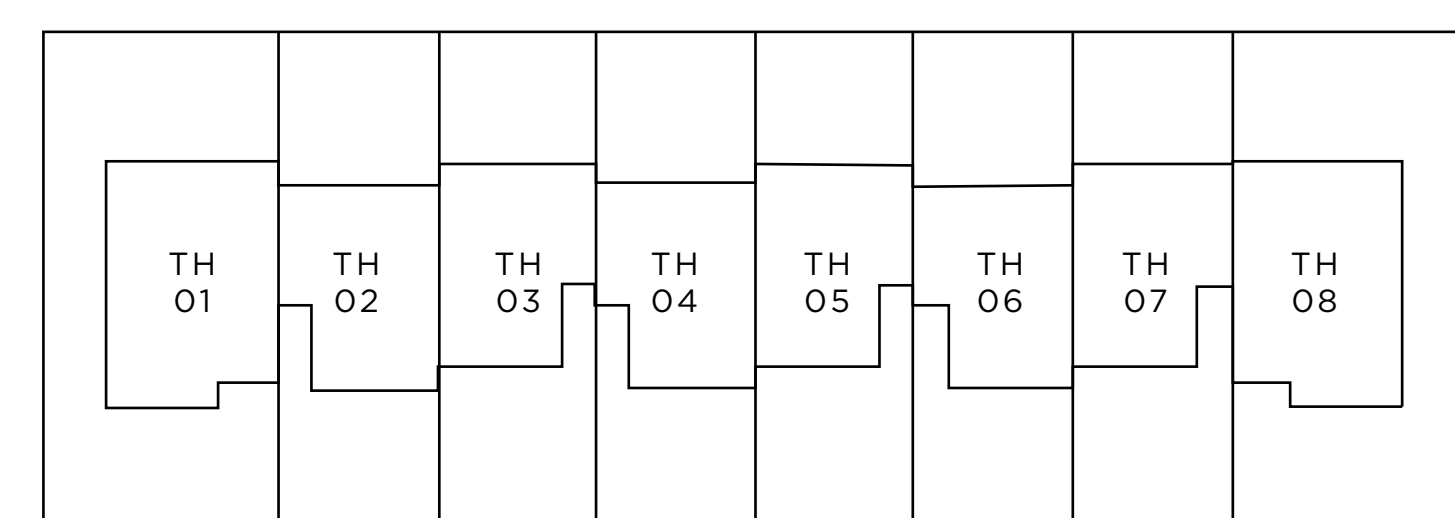

8 PLEX
STREET SIDE

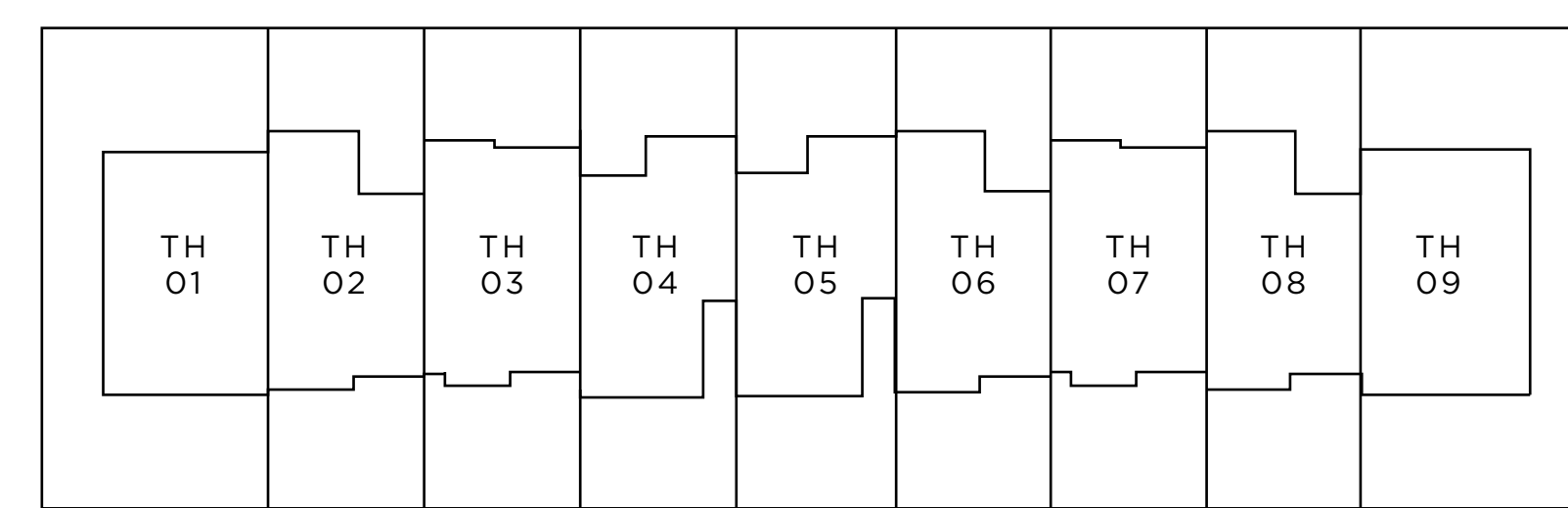

9 PLEX
STREET SIDE

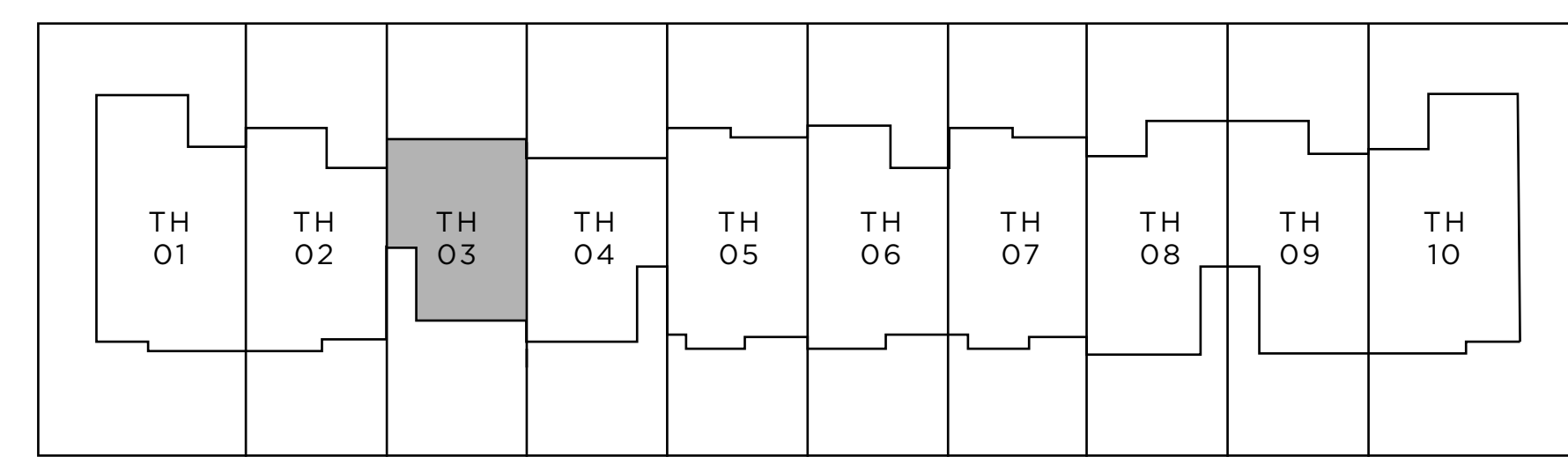

10 PLEX
STREET SIDE

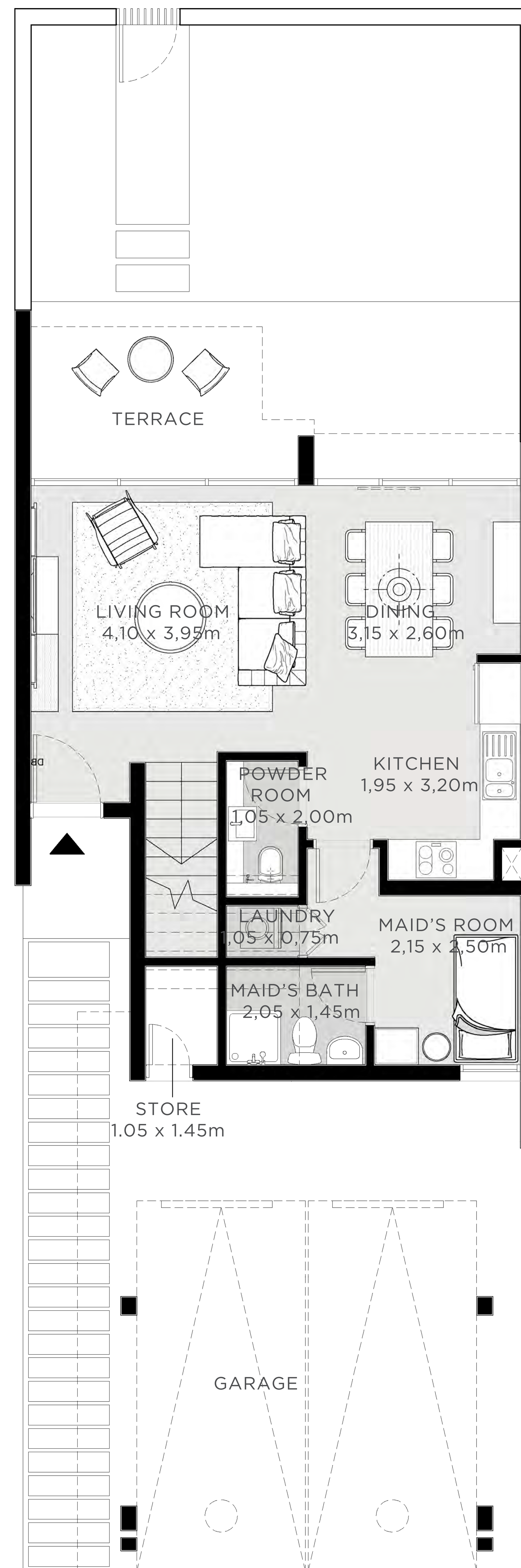

GROUND FLOOR

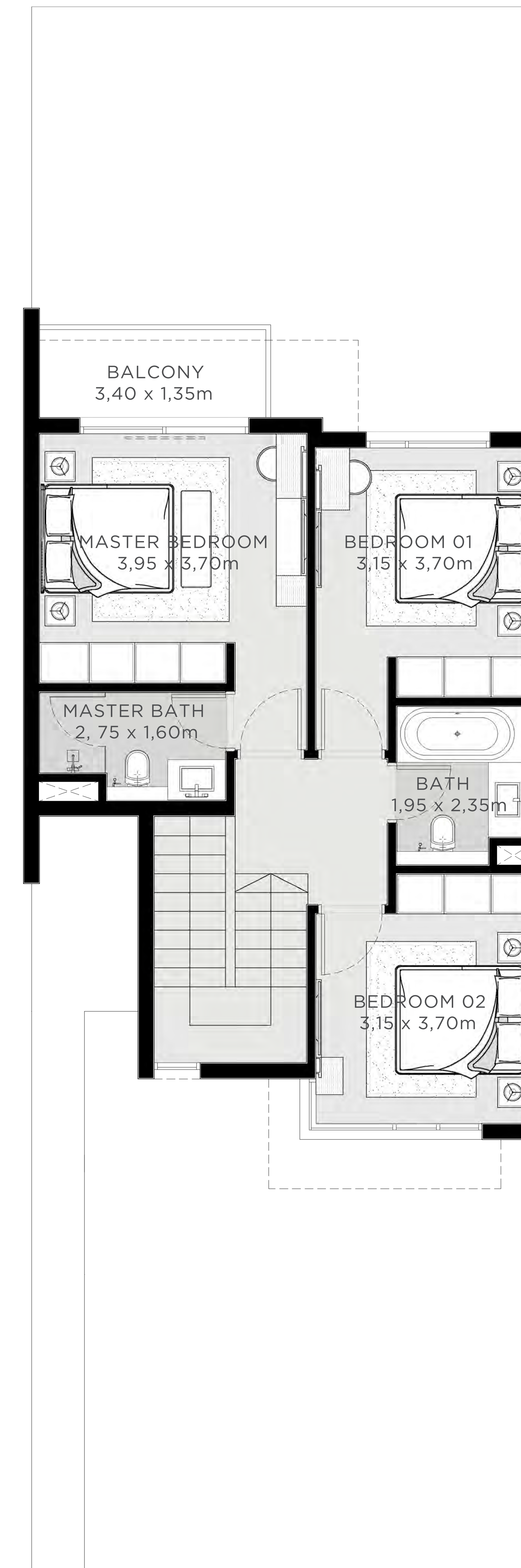

FIRST FLOOR

FLOOR PLAN 1. All dimensions are in imperial and metric, and measured from finish to finish excluding construction tolerances. 2. All materials, dimensions, and drawings are approximate only. 3. Information is subject to change without notice, at developer's absolute discretion. 4. Actual area may vary from the stated area. 5. Drawings not to scale. 6. All images used are for illustrative purposes only and do not represent the actual size, features, specifications, fittings, and furnishings. 7. The developer reserves the right to make revisions / alterations, at it's absolute discretion, without any liability whatsoever.

THE VALLEY

EDEN

SPRUCE 3 BEDROOM 1 D

UNIT	TOTAL AREA
10 PLEX - TH 04	1972.48 SQFT 183.25 SQM

KEY PLAN

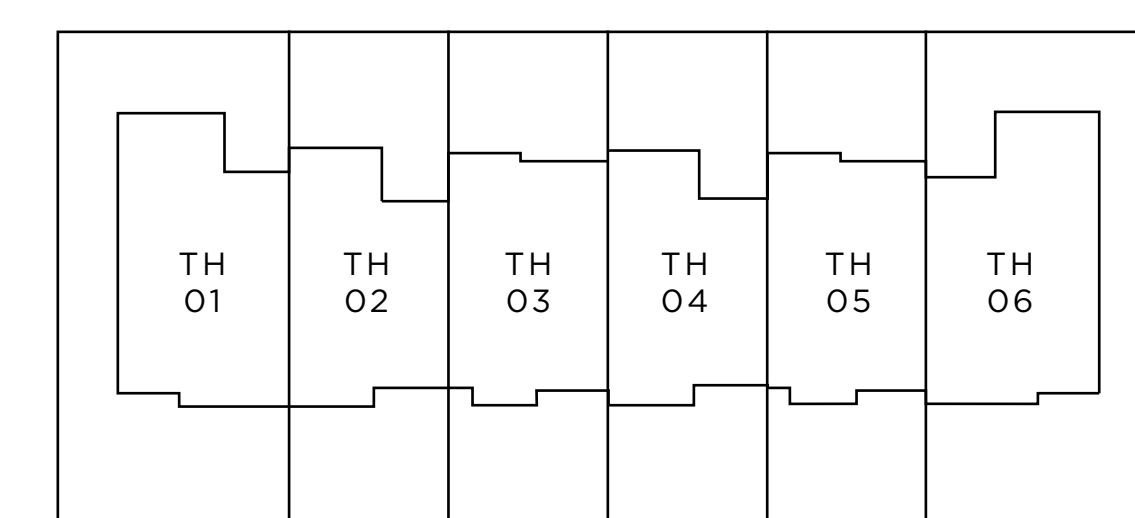

6 PLEX
STREET SIDE

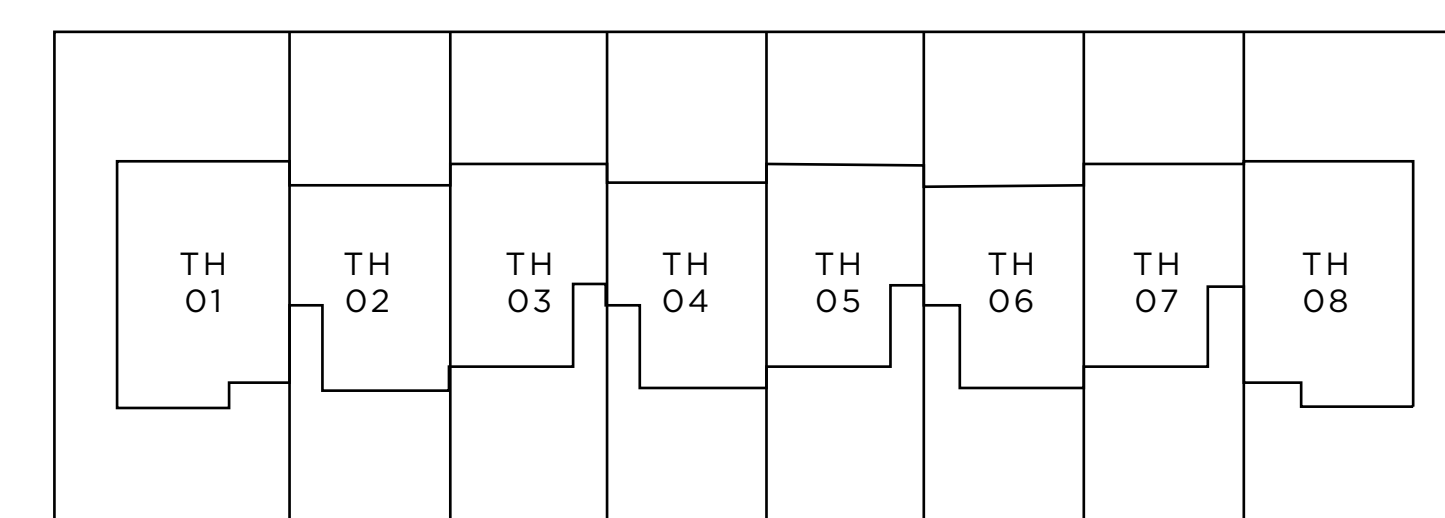

8 PLEX
STREET SIDE

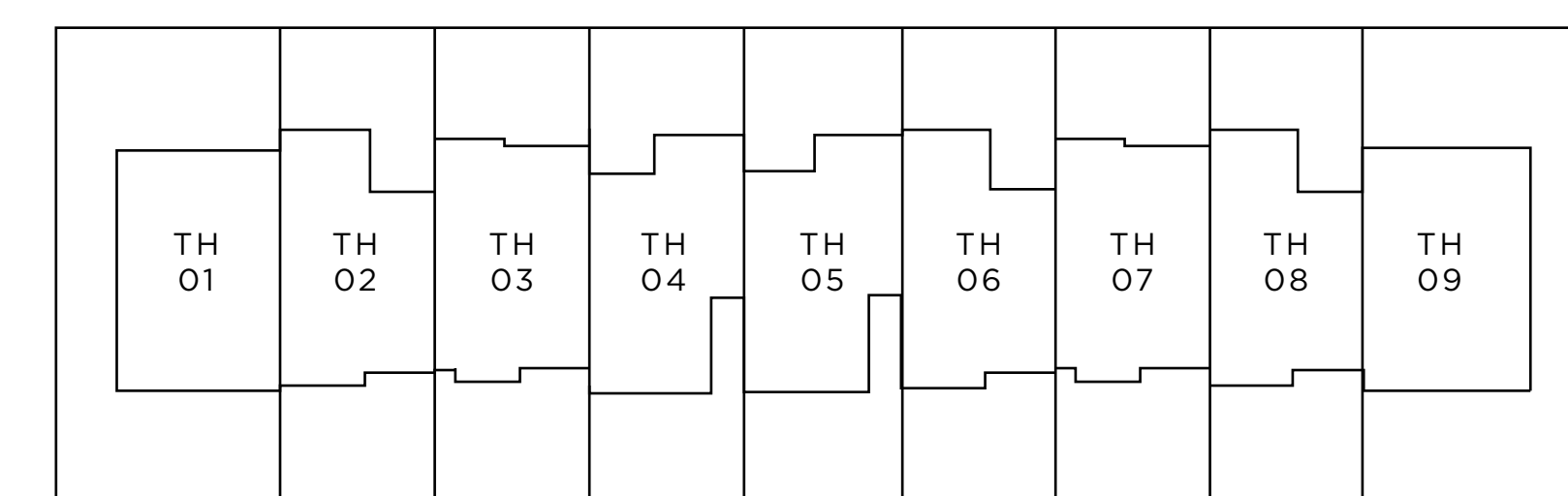

9 PLEX
STREET SIDE

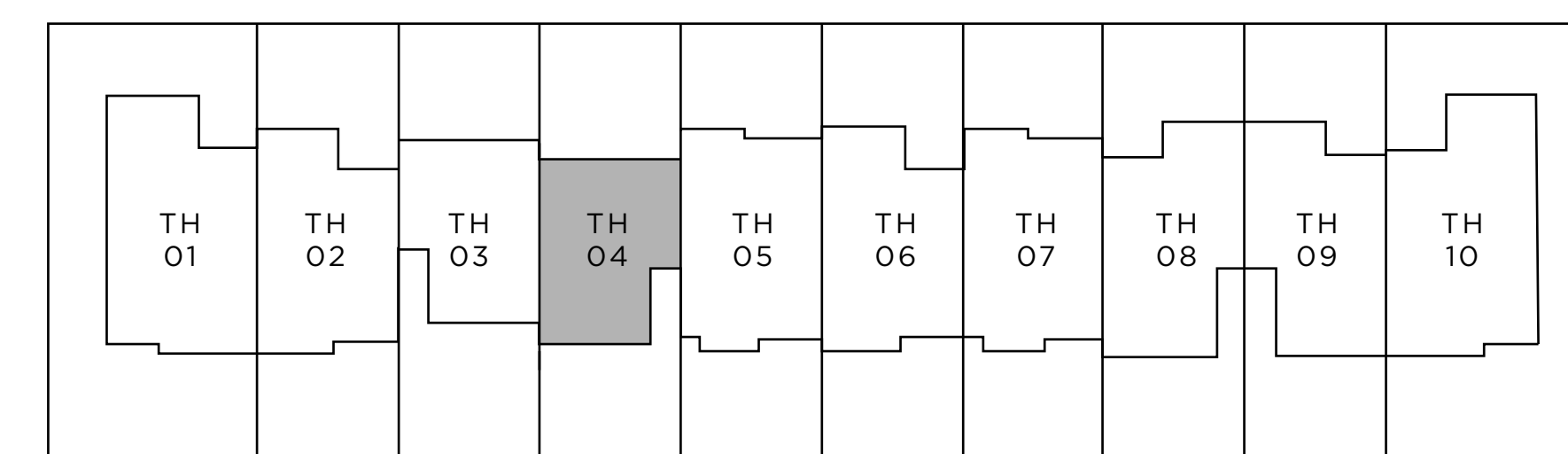

10 PLEX
STREET SIDE

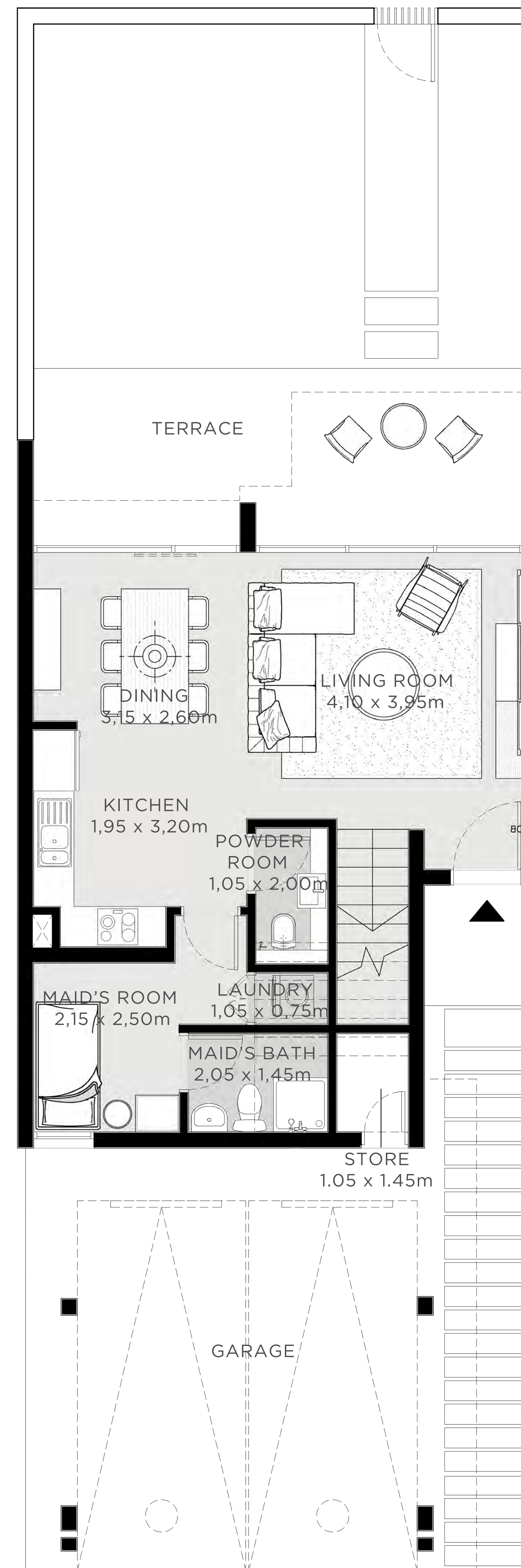

GROUND FLOOR

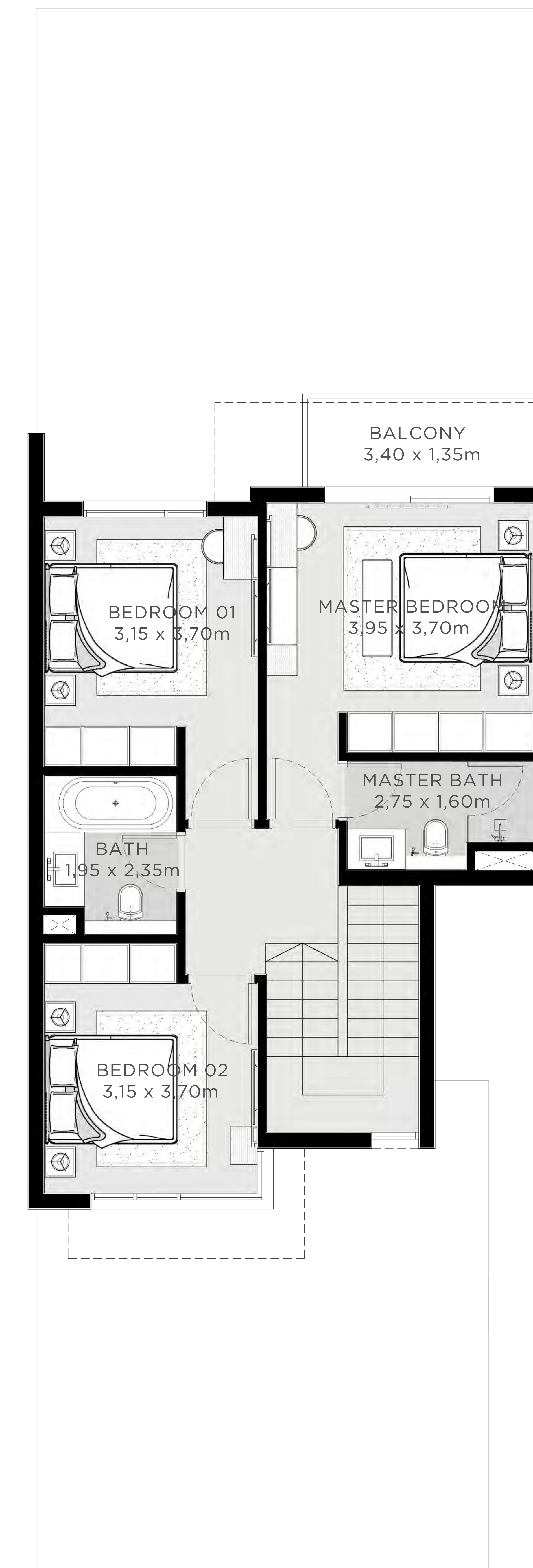

FIRST FLOOR

FLOOR PLAN 1. All dimensions are in imperial and metric, and measured from finish to finish excluding construction tolerances. 2. All materials, dimensions, and drawings are approximate only. 3. Information is subject to change without notice, at developer's absolute discretion. 4. Actual area may vary from the stated area. 5. Drawings not to scale. 6. All images used are for illustrative purposes only and do not represent the actual size, features, specifications, fittings, and furnishings. 7. The developer reserves the right to make revisions / alterations, at it's absolute discretion, without any liability whatsoever.

THE VALLEY

EDEN

SPRUCE
4 BEDROOM 1 A

UNIT	TOTAL AREA	
8 PLEX - TH 01	2322.52 SQFT	215.77 SQM

KEY PLAN

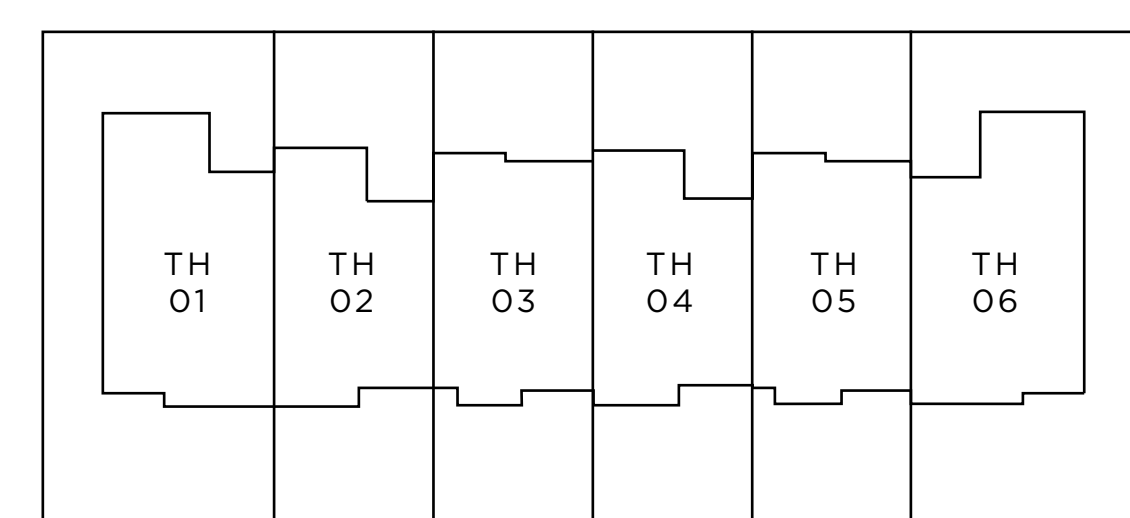

6 PLEX
STREET SIDE

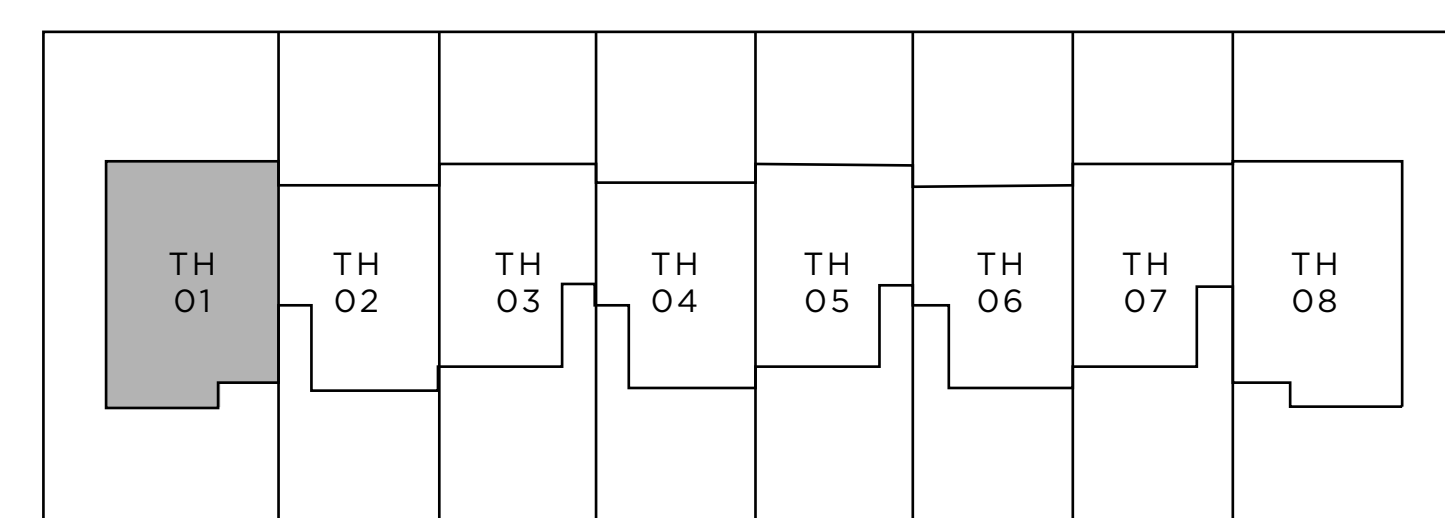

8 PLEX
STREET SIDE

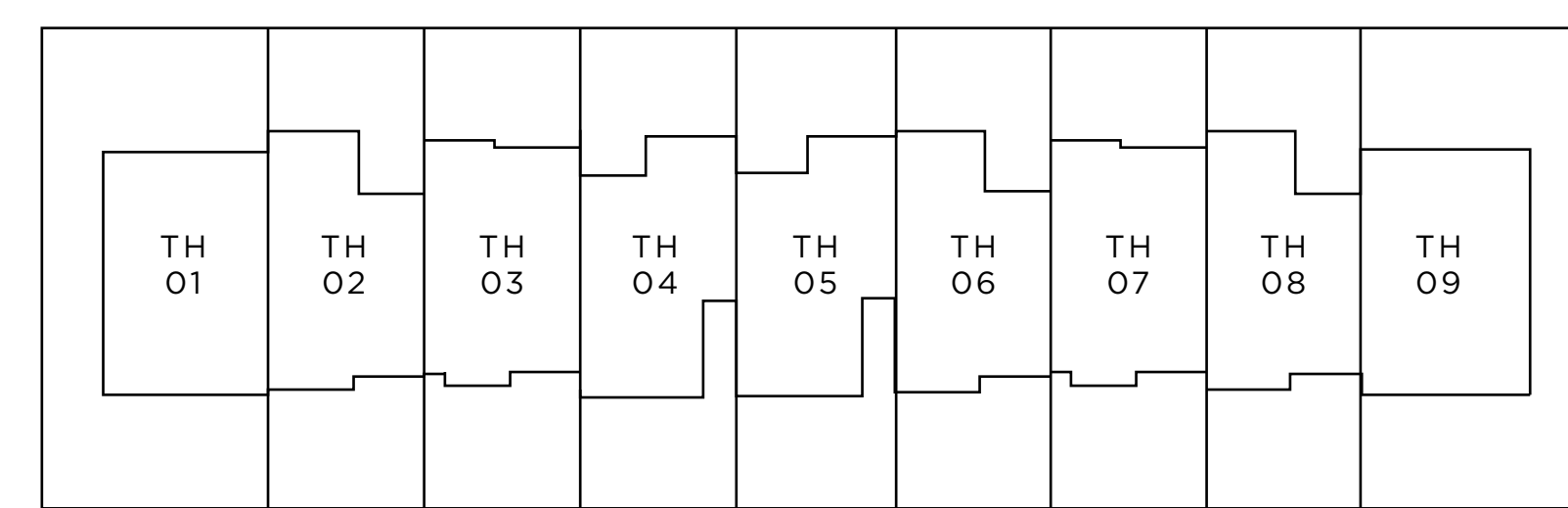

9 PLEX
STREET SIDE

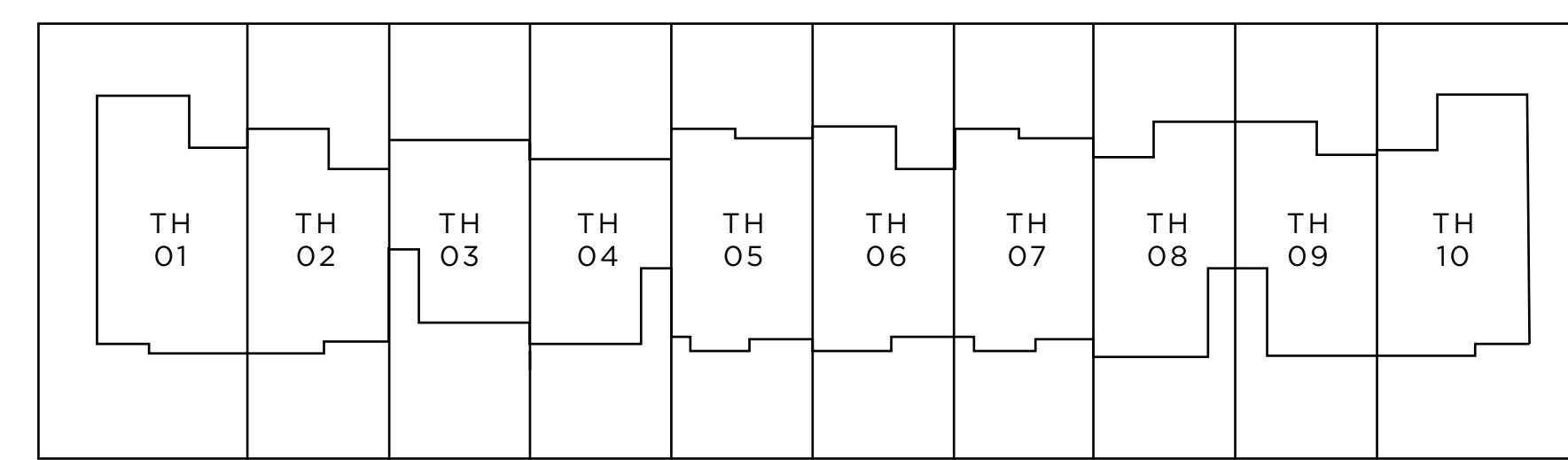

10 PLEX
STREET SIDE

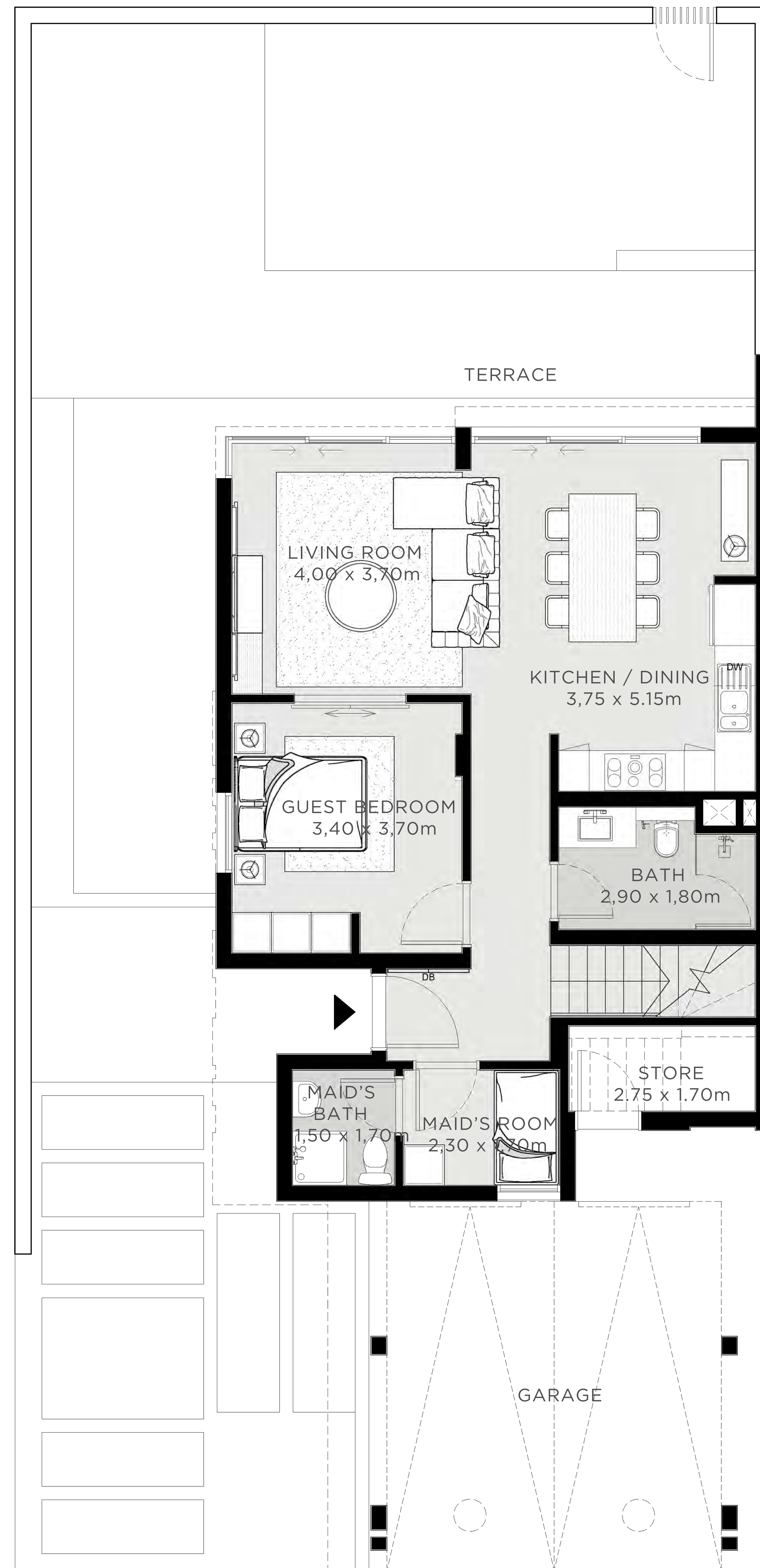

GROUND FLOOR

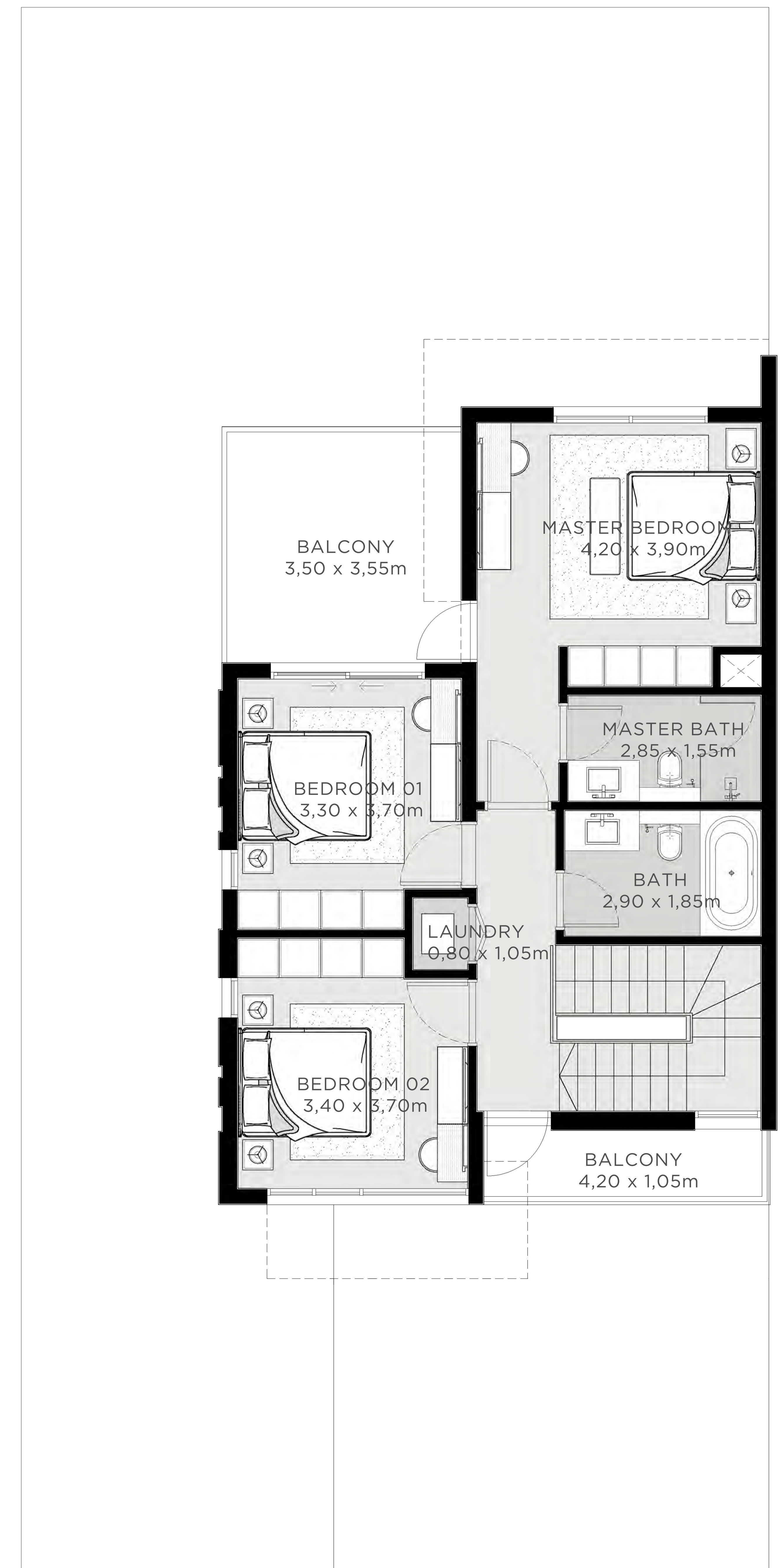

FIRST FLOOR

FLOOR PLAN 1. All dimensions are in imperial and metric, and measured from finish to finish excluding construction tolerances. 2. All materials, dimensions, and drawings are approximate only. 3. Information is subject to change without notice, at developer's absolute discretion. 4. Actual area may vary from the stated area. 5. Drawings not to scale. 6. All images used are for illustrative purposes only and do not represent the actual size, features, specifications, fittings, and furnishings. 7. The developer reserves the right to make revisions / alterations, at it's absolute discretion, without any liability whatsoever.

THE VALLEY

EDEN

SPRUCE
4 BEDROOM I B

UNIT	TOTAL AREA	
8 PLEX - TH 08	2325.32 SQFT	216.03 SQM

KEY PLAN

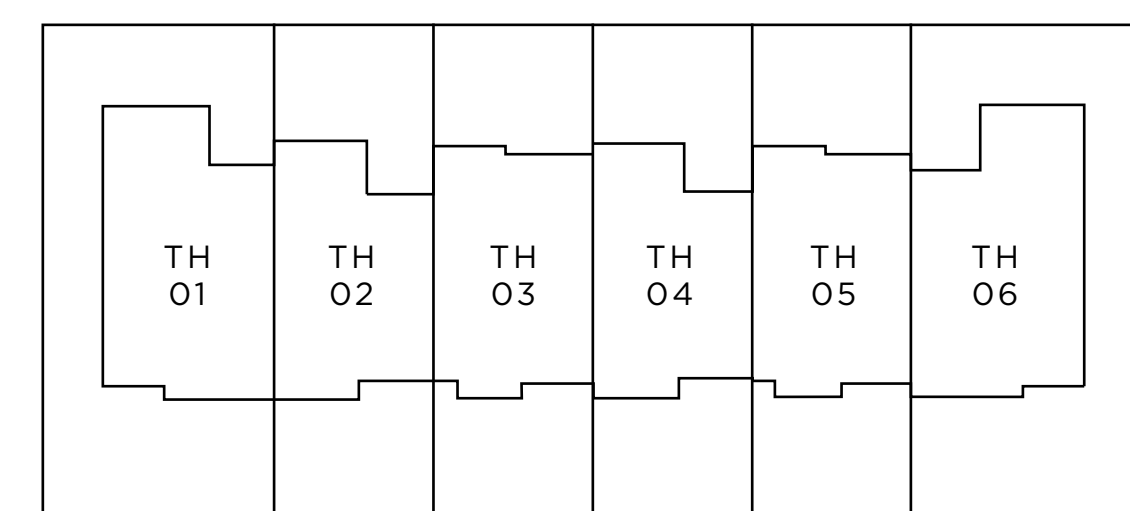

6 PLEX
STREET SIDE

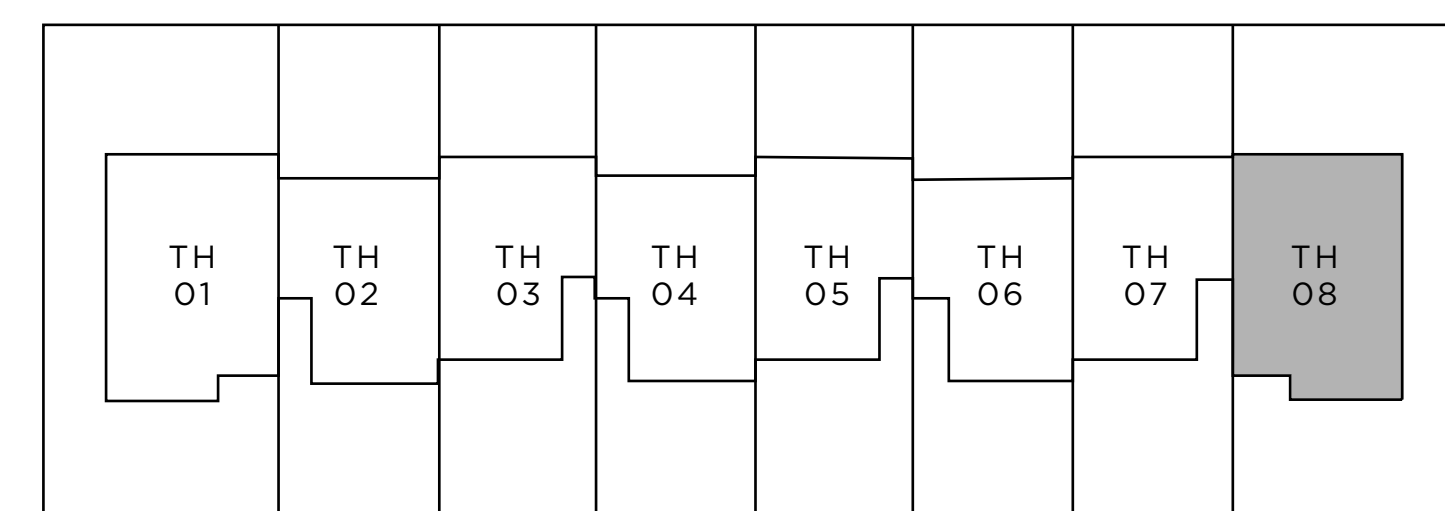

8 PLEX
STREET SIDE

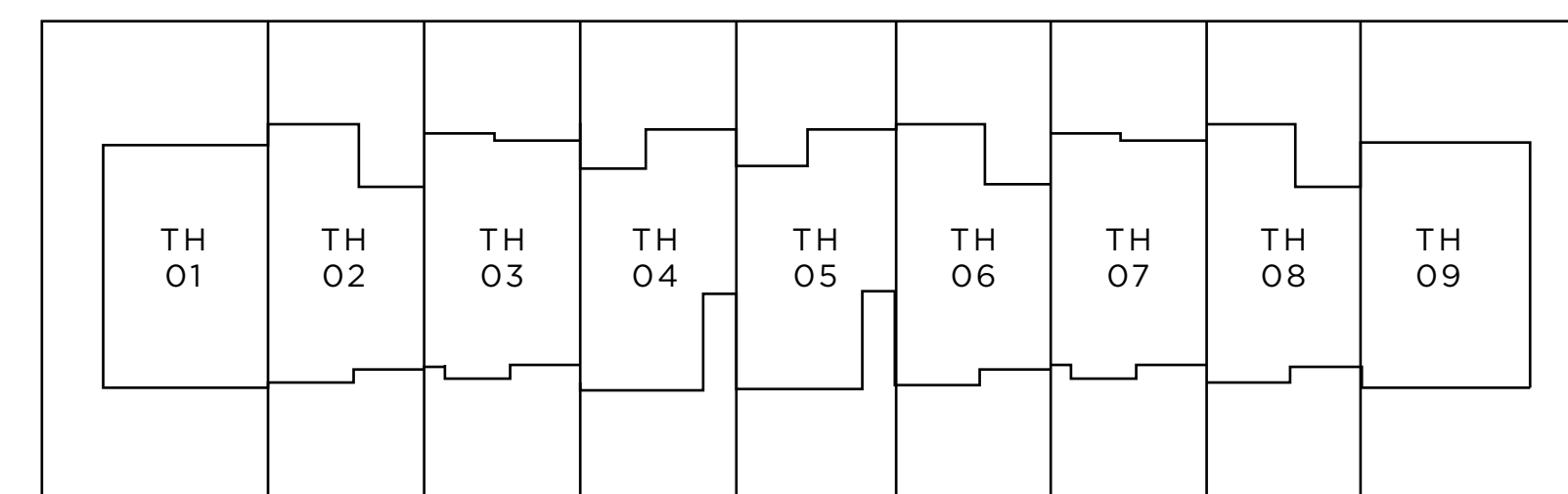

9 PLEX
STREET SIDE

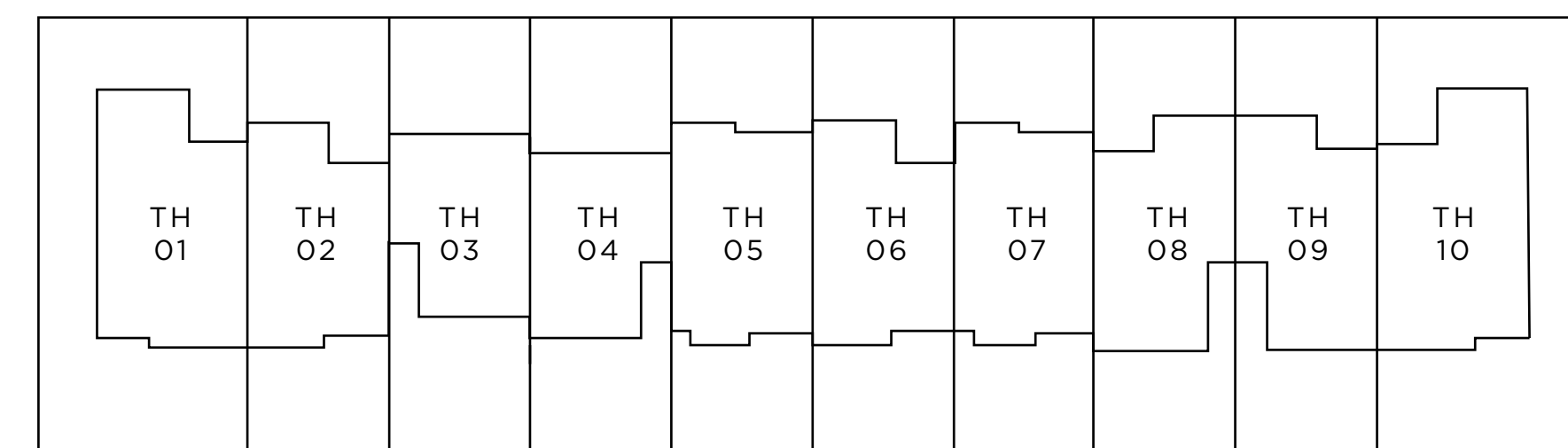

10 PLEX
STREET SIDE

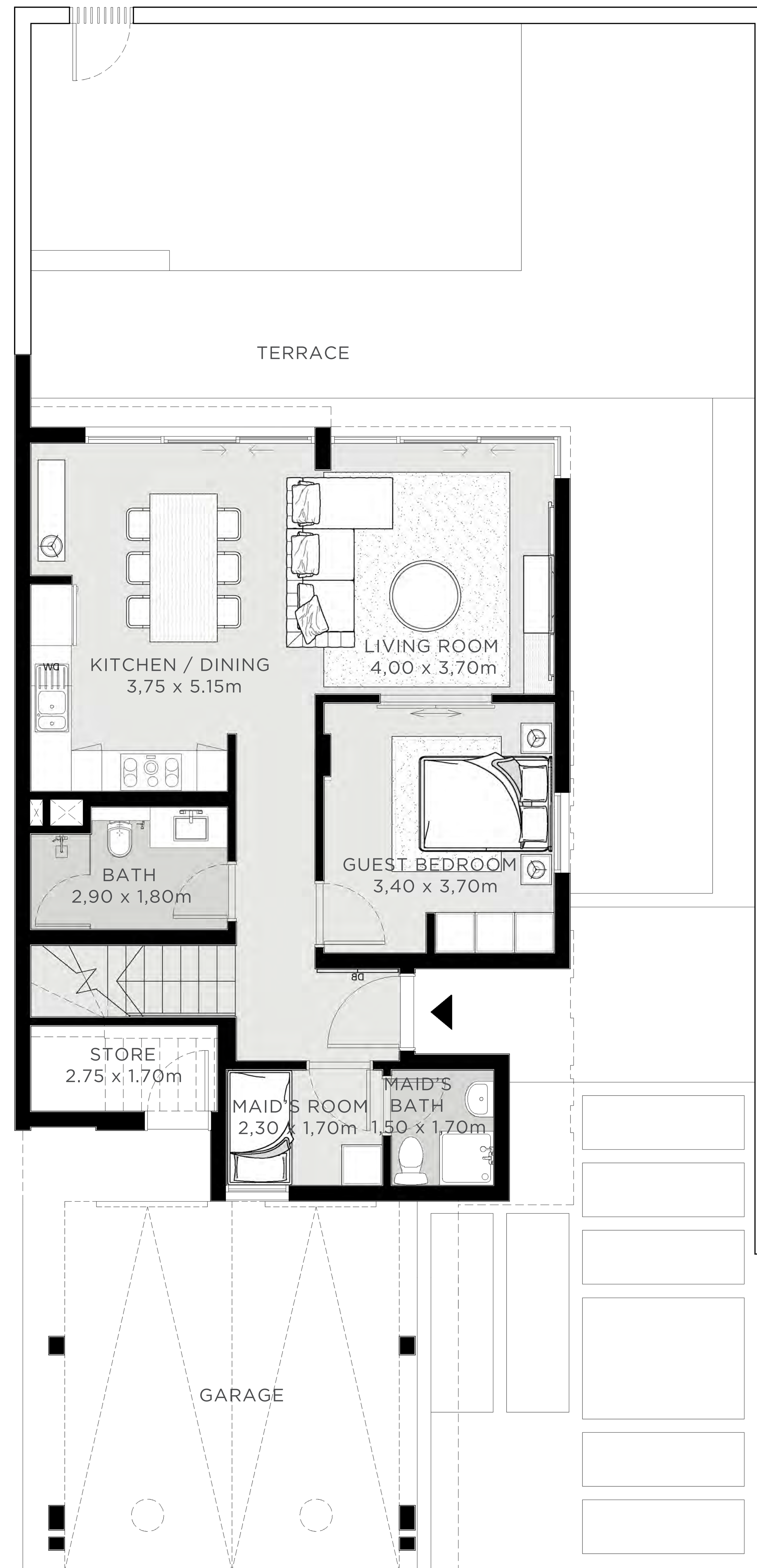

GROUND FLOOR

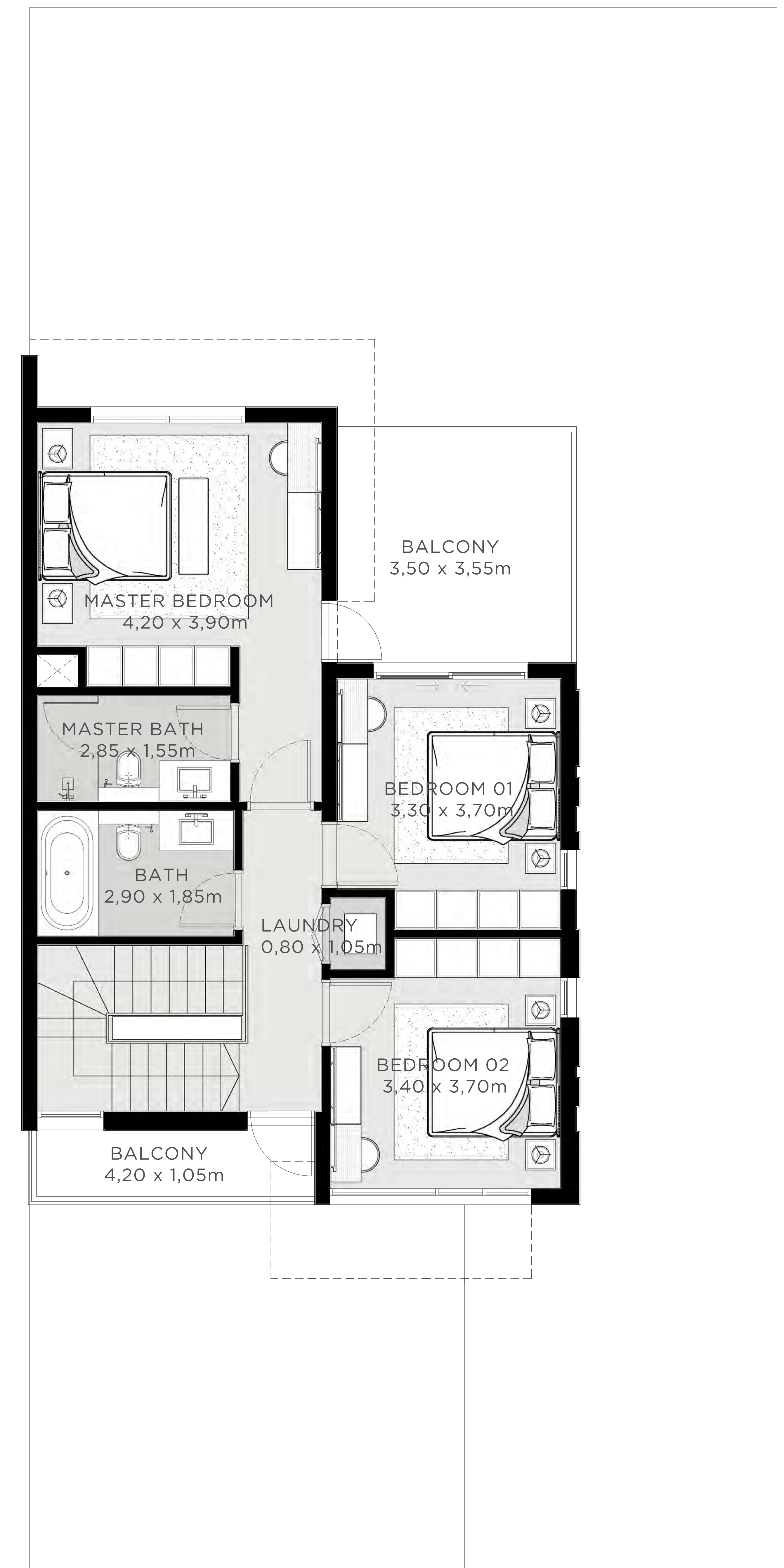

FIRST FLOOR

FLOOR PLAN 1. All dimensions are in imperial and metric, and measured from finish to finish excluding construction tolerances. 2. All materials, dimensions, and drawings are approximate only. 3. Information is subject to change without notice, at developer's absolute discretion. 4. Actual area may vary from the stated area. 5. Drawings not to scale. 6. All images used are for illustrative purposes only and do not represent the actual size, features, specifications, fittings, and furnishings. 7. The developer reserves the right to make revisions / alterations, at it's absolute discretion, without any liability whatsoever.

V
THE VALLEY

EDEN

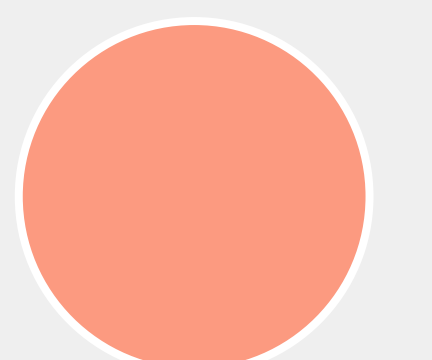

IRIS

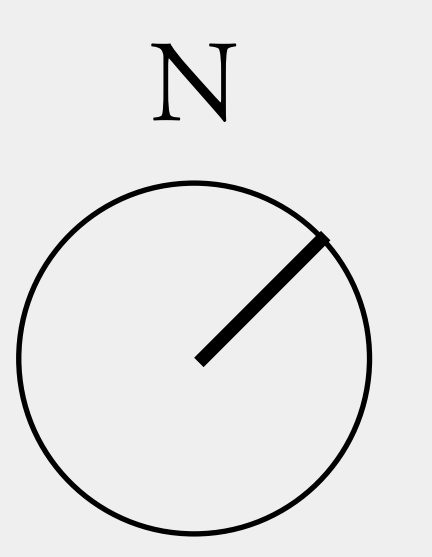

FLOOR PLAN 1. All dimensions are in imperial and metric, and measured from finish to finish excluding construction tolerances. 2. All materials, dimensions, and drawings are approximate only. 3. Information is subject to change without notice, at developer's absolute discretion. 4. Actual area may vary from the stated area. 5. Drawings not to scale. 6. All images used are for illustrative purposes only and do not represent the actual size, features, specifications, fittings, and furnishings. 7. The developer reserves the right to make revisions / alterations, at it's absolute discretion, without any liability whatsoever.

THE VALLEY

EDEN

IRIS 3 BEDROOM 1 A

UNIT	TOTAL AREA	
6 PLEX - TH 02	2052.03 SQFT	190.64 SQM
6 PLEX - TH 04	2051.06 SQFT	190.55 SQM
9 PLEX - TH 02	2051.17 SQFT	190.56 SQM
9 PLEX - TH 06	2081.74 SQFT	193.40 SQM
9 PLEX - TH 08	2049.87 SQFT	190.44 SQM
10 PLEX - TH 02	2054.18 SQFT	190.84 SQM
10 PLEX - TH 06	2081.09 SQFT	193.34 SQM

KEY PLAN

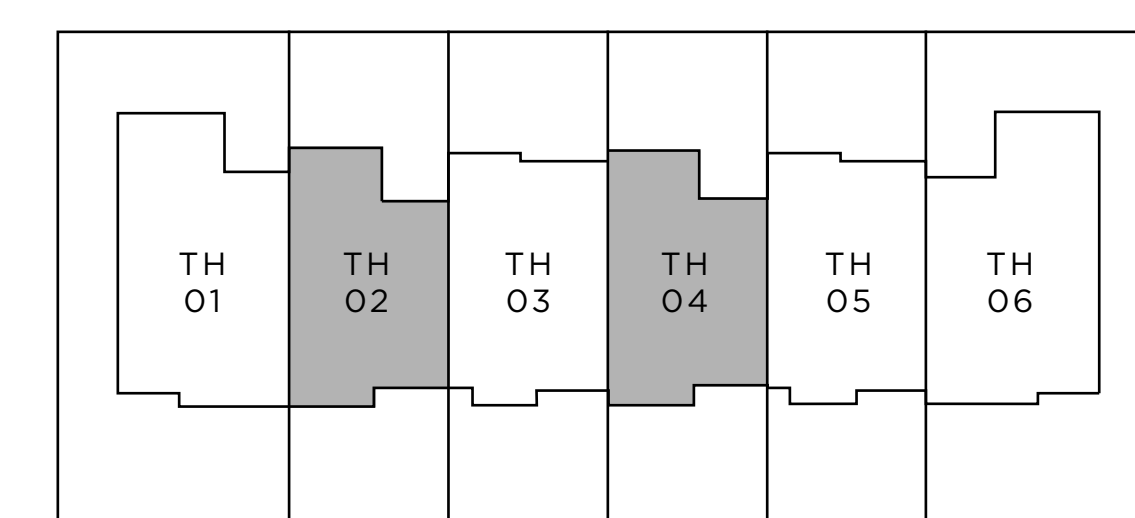

6 PLEX
STREET SIDE

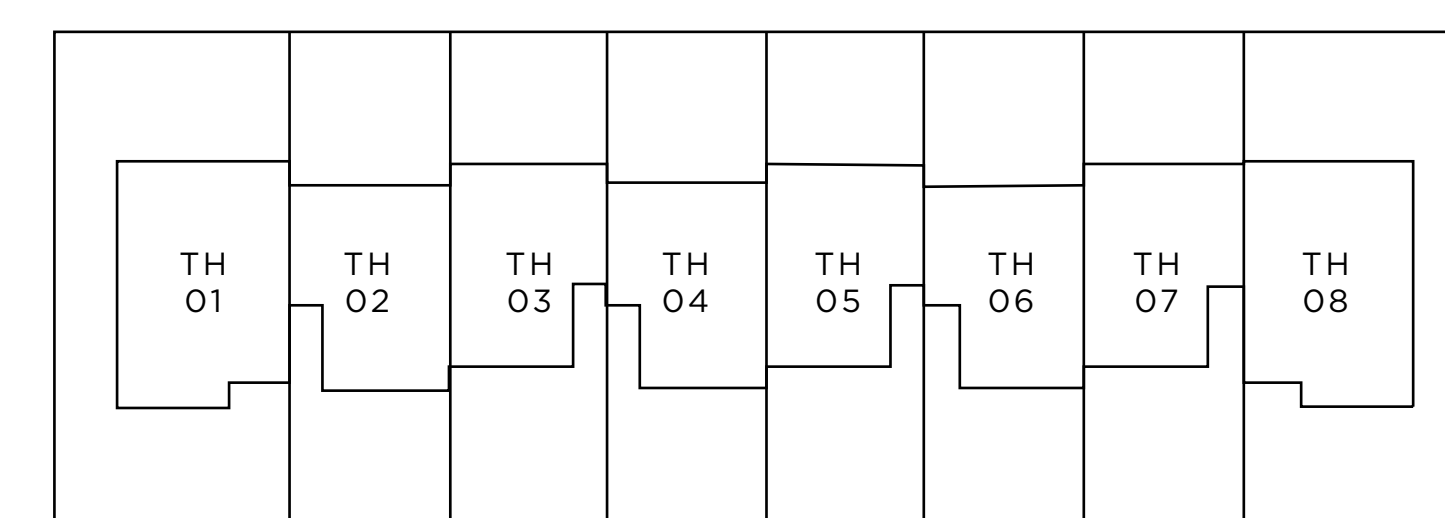

8 PLEX
STREET SIDE

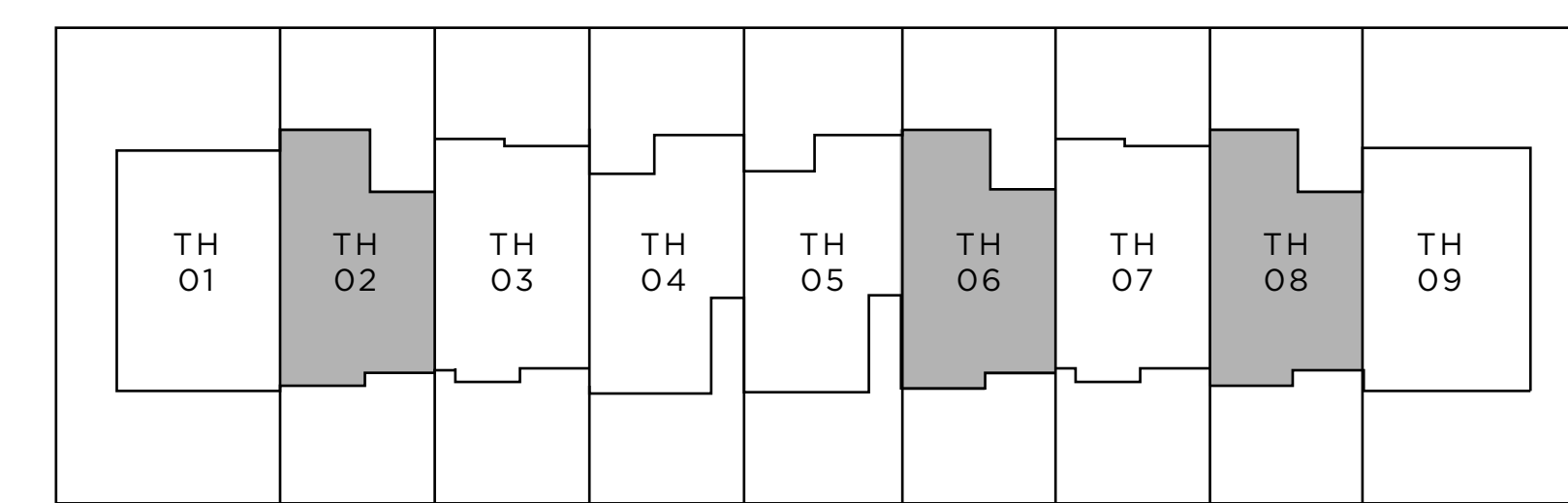

9 PLEX
STREET SIDE

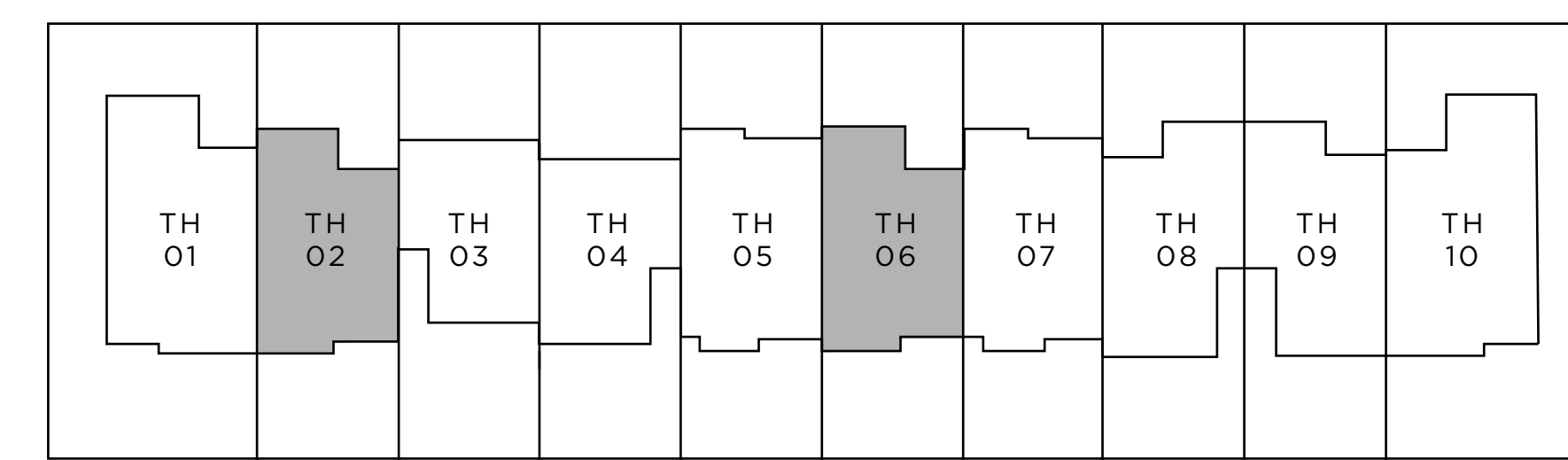

10 PLEX
STREET SIDE

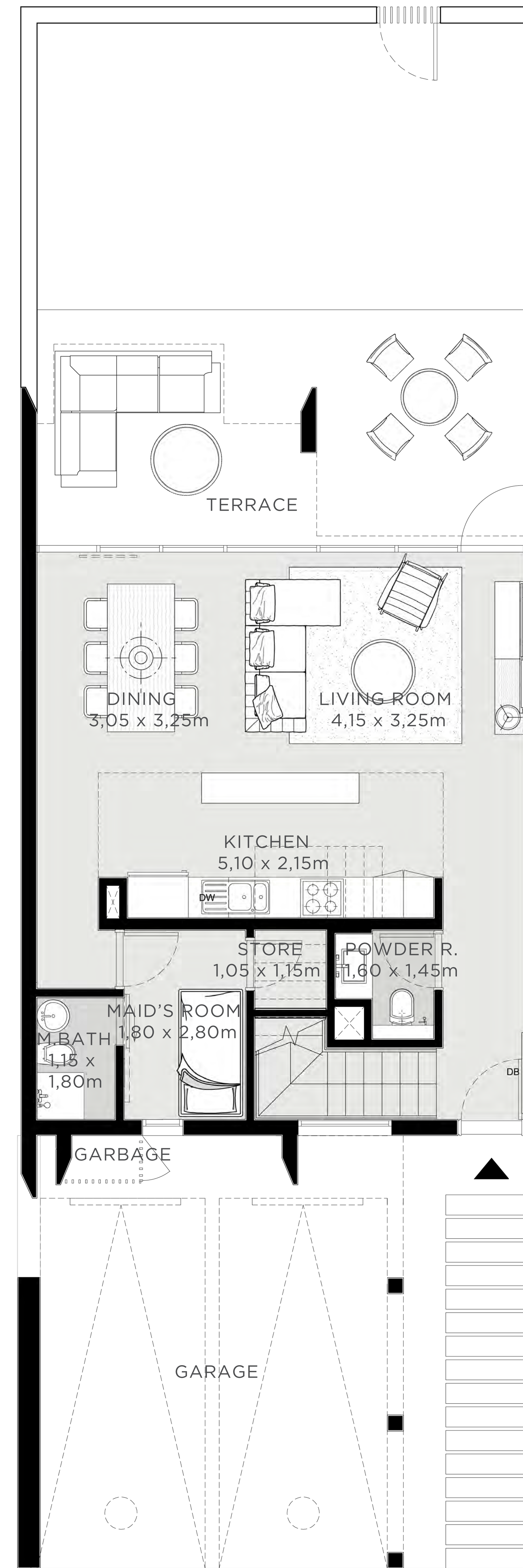

GROUND FLOOR

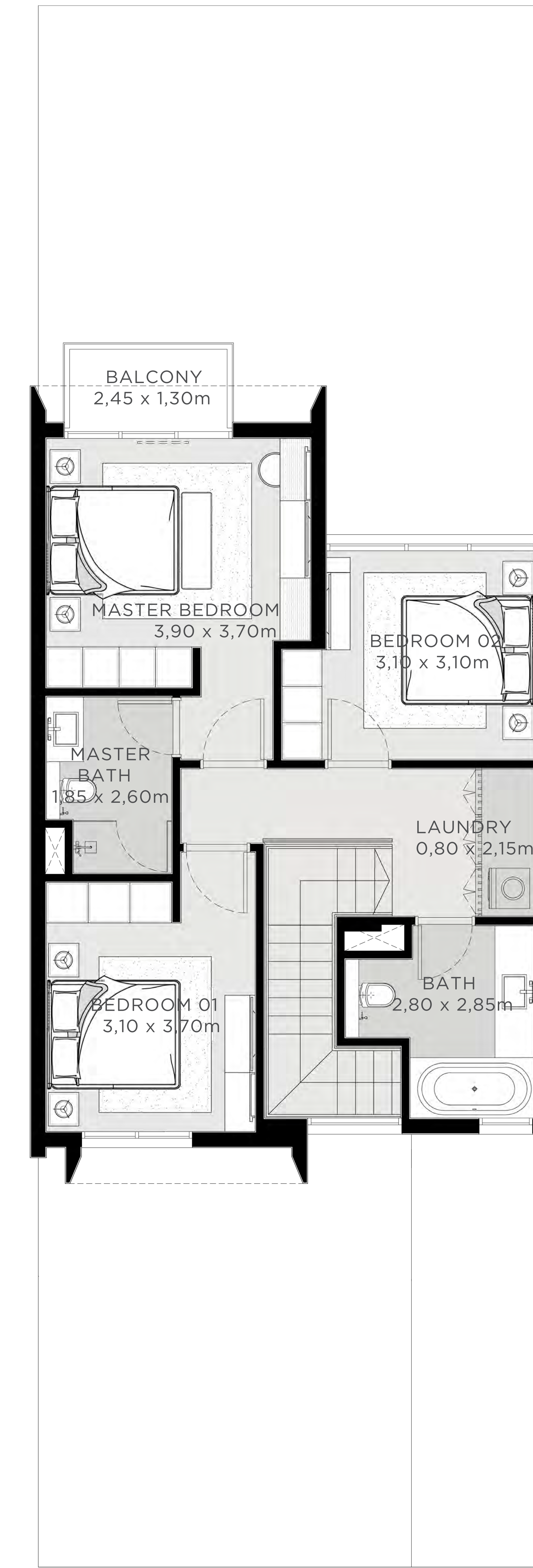

FIRST FLOOR

FLOOR PLAN 1. All dimensions are in imperial and metric, and measured from finish to finish excluding construction tolerances. 2. All materials, dimensions, and drawings are approximate only. 3. Information is subject to change without notice, at developer's absolute discretion. 4. Actual area may vary from the stated area. 5. Drawings not to scale. 6. All images used are for illustrative purposes only and do not represent the actual size, features, specifications, fittings, and furnishings. 7. The developer reserves the right to make revisions / alterations, at it's absolute discretion, without any liability whatsoever.

THE VALLEY

EDEN

**IRIS
3 BEDROOM I B**

UNIT	TOTAL AREA	
6 PLEX - TH 03	2058.92 SQFT	191.28 SQM
6 PLEX - TH 05	2058.38 SQFT	191.23 SQM
9 PLEX - TH 03	2058.92 SQFT	191.28 SQM
9 PLEX - TH 07	2058.92 SQFT	191.28 SQM
10 PLEX - TH 05	2086.58 SQFT	193.85 SQM
10 PLEX - TH 07	2057.73 SQFT	191.17 SQM

KEY PLAN

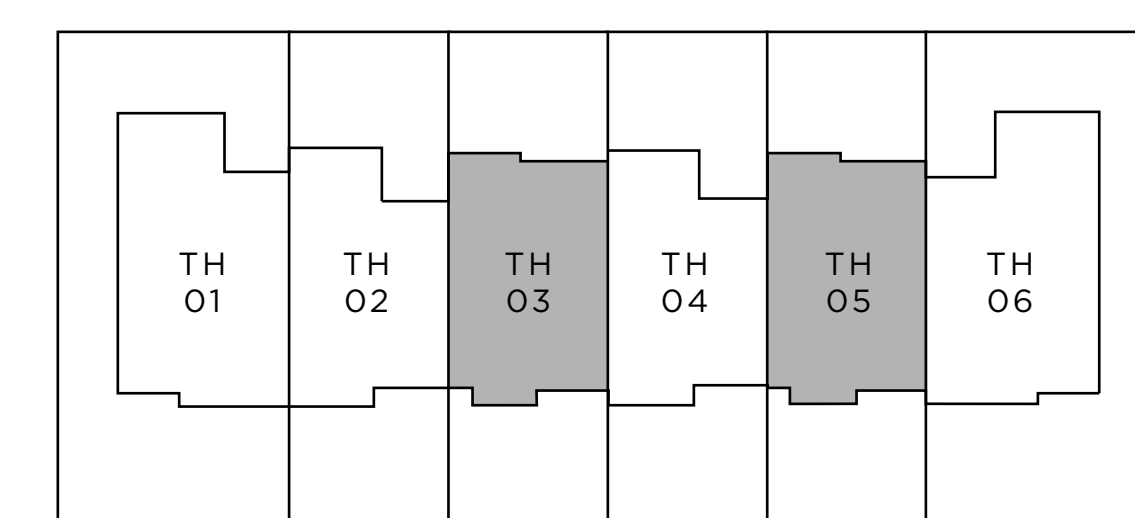

6 PLEX
STREET SIDE

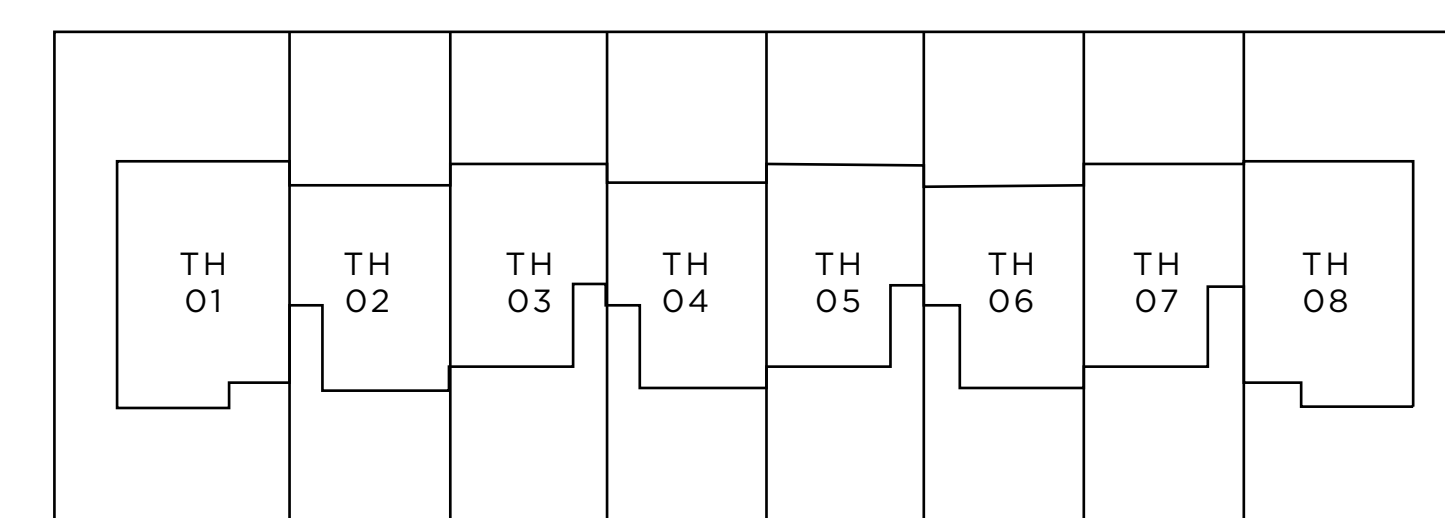

8 PLEX
STREET SIDE

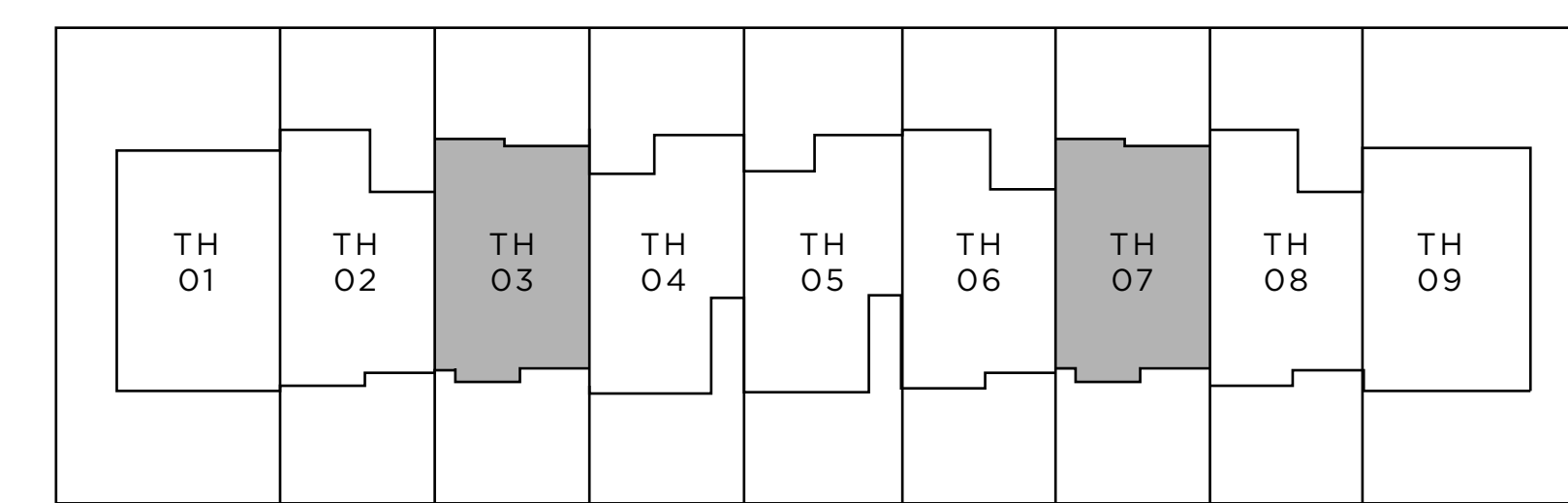

9 PLEX
STREET SIDE

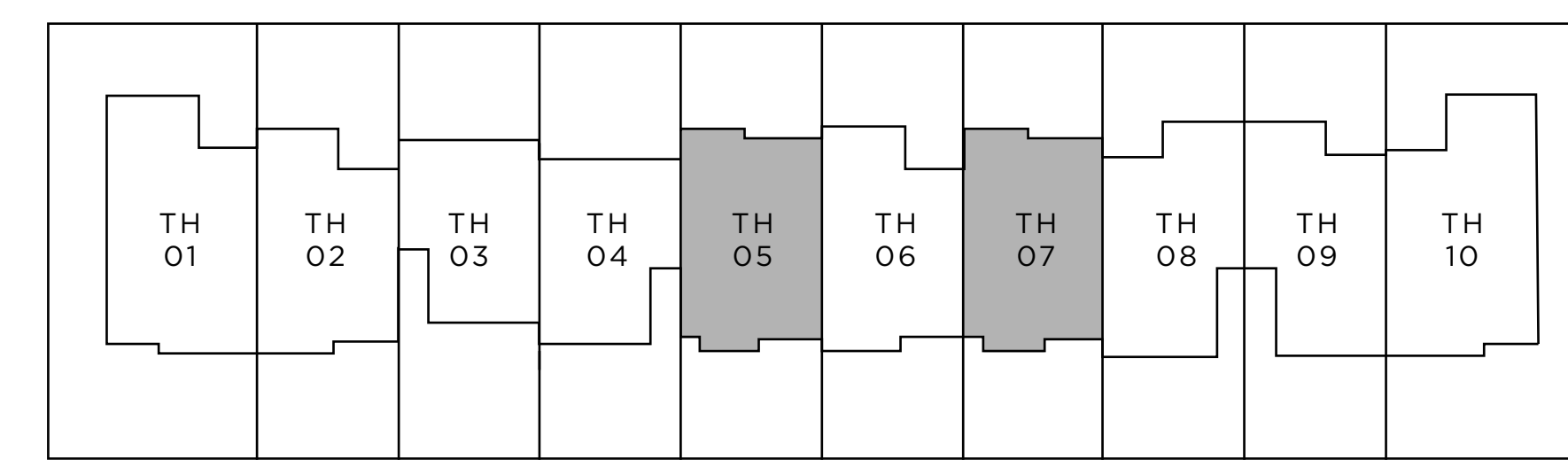

10 PLEX
STREET SIDE

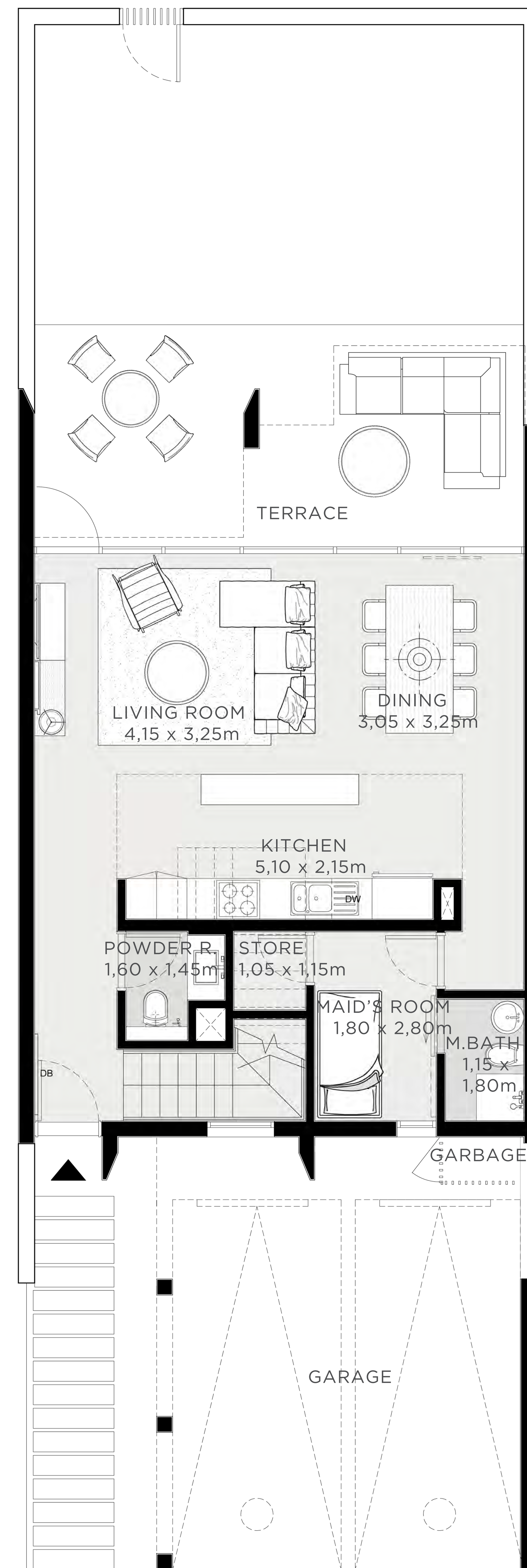

GROUND FLOOR

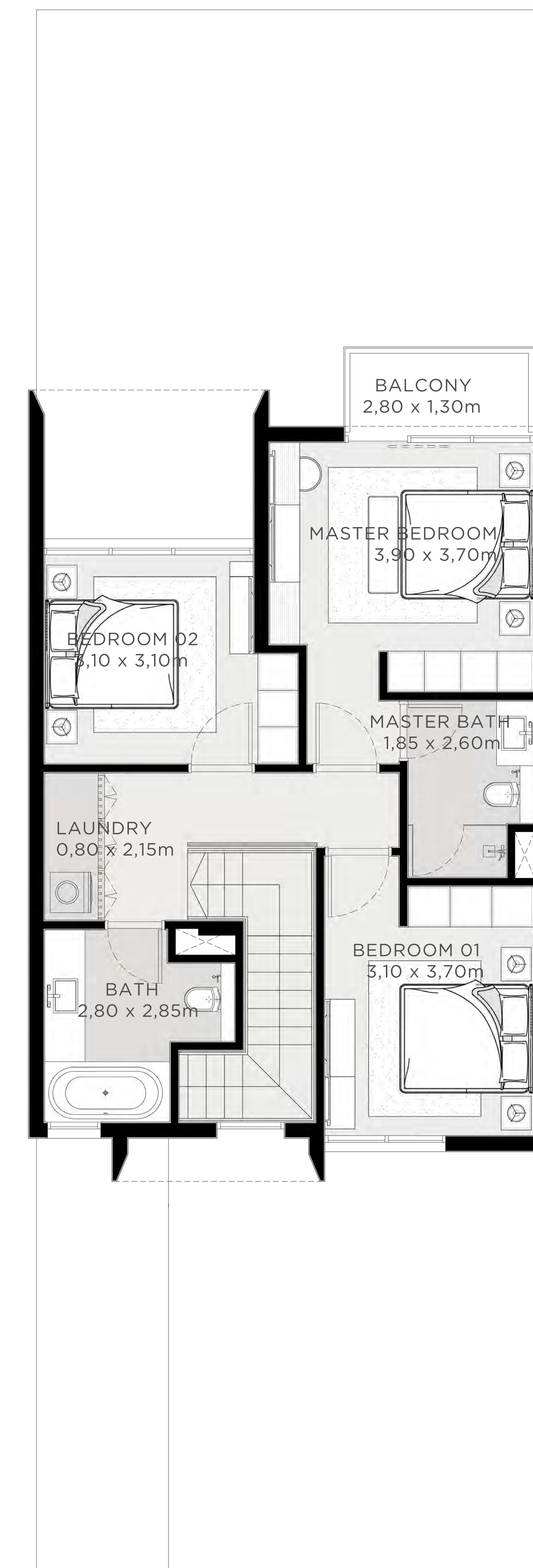

FIRST FLOOR

FLOOR PLAN 1. All dimensions are in imperial and metric, and measured from finish to finish excluding construction tolerances. 2. All materials, dimensions, and drawings are approximate only. 3. Information is subject to change without notice, at developer's absolute discretion. 4. Actual area may vary from the stated area. 5. Drawings not to scale. 6. All images used are for illustrative purposes only and do not represent the actual size, features, specifications, fittings, and furnishings. 7. The developer reserves the right to make revisions / alterations, at it's absolute discretion, without any liability whatsoever.

THE VALLEY

EDEN

**IRIS
4 BEDROOM 1 A**

UNIT	TOTAL AREA	
6 PLEX - TH 01	2336.19 SQFT	217.04 SQM
10 PLEX - TH 01	2335.33 SQFT	216.96 SQM

KEY PLAN

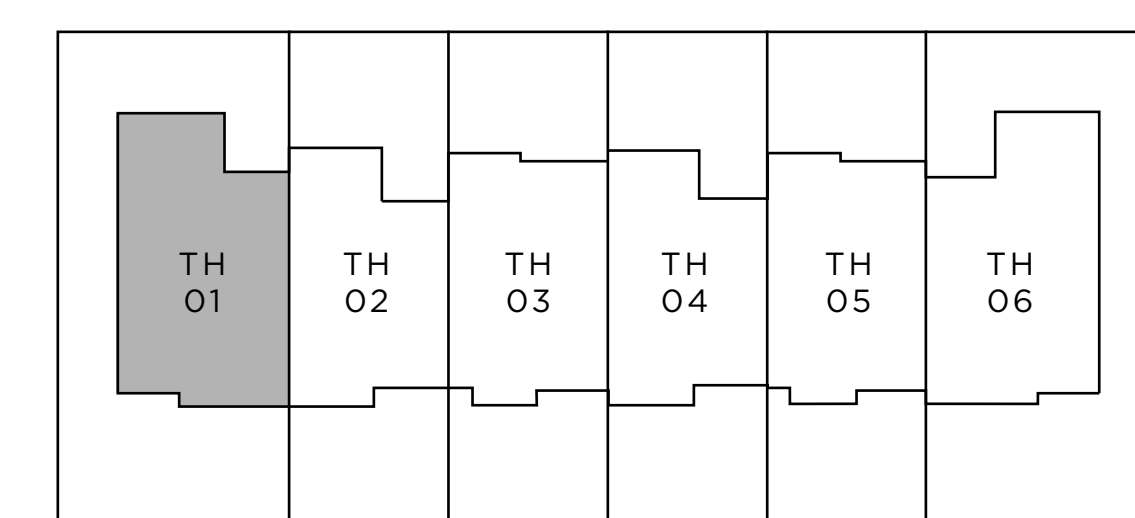

6 PLEX
STREET SIDE

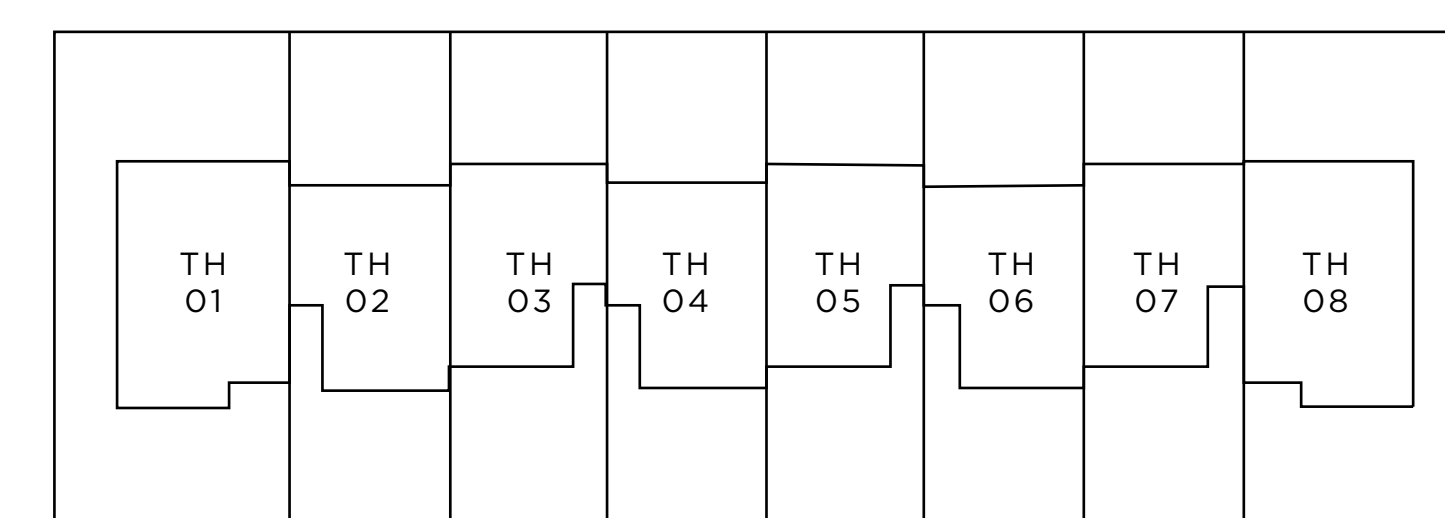

8 PLEX
STREET SIDE

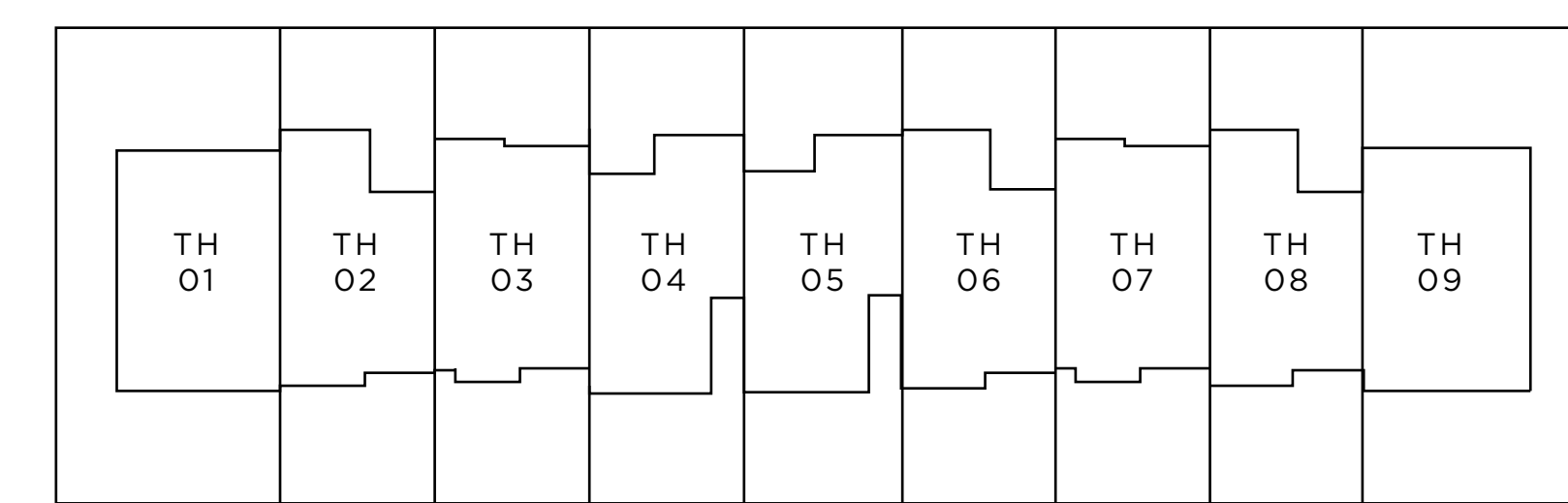

9 PLEX
STREET SIDE

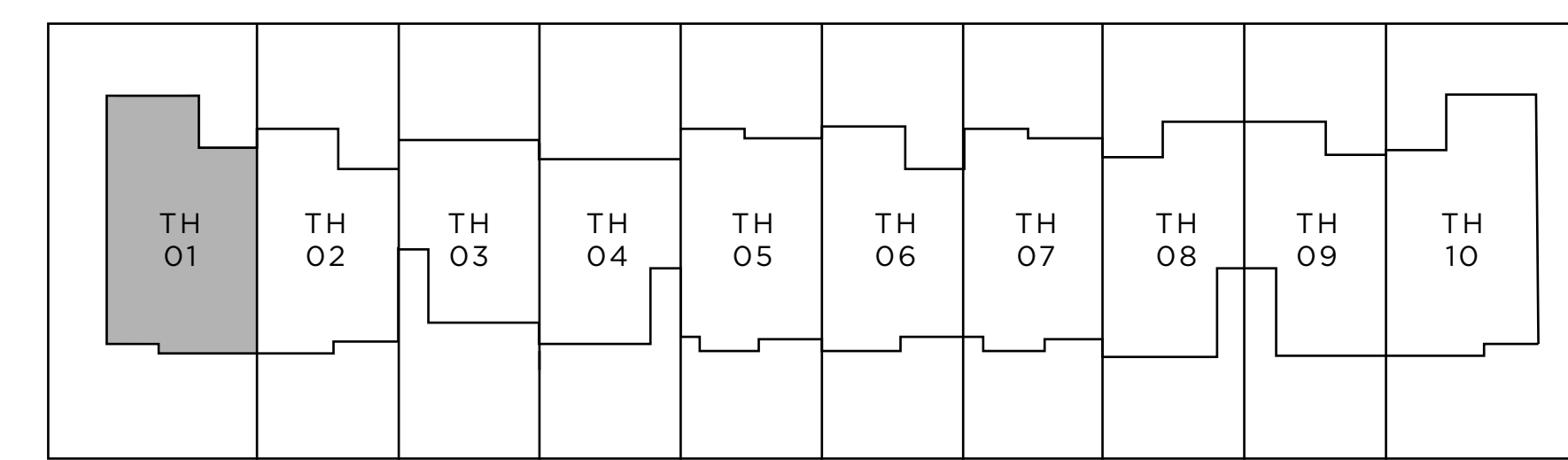

10 PLEX
STREET SIDE

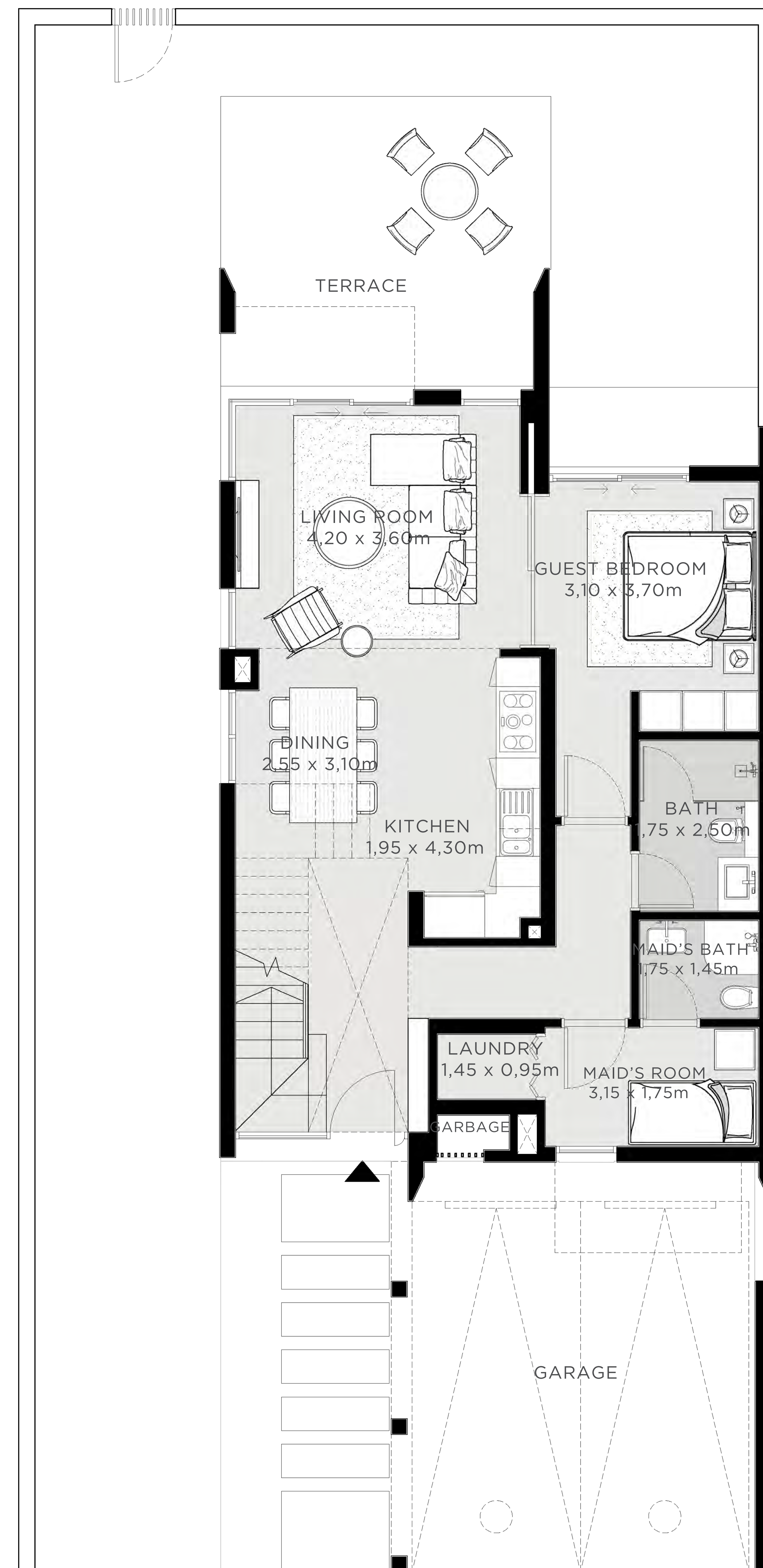

GROUND FLOOR

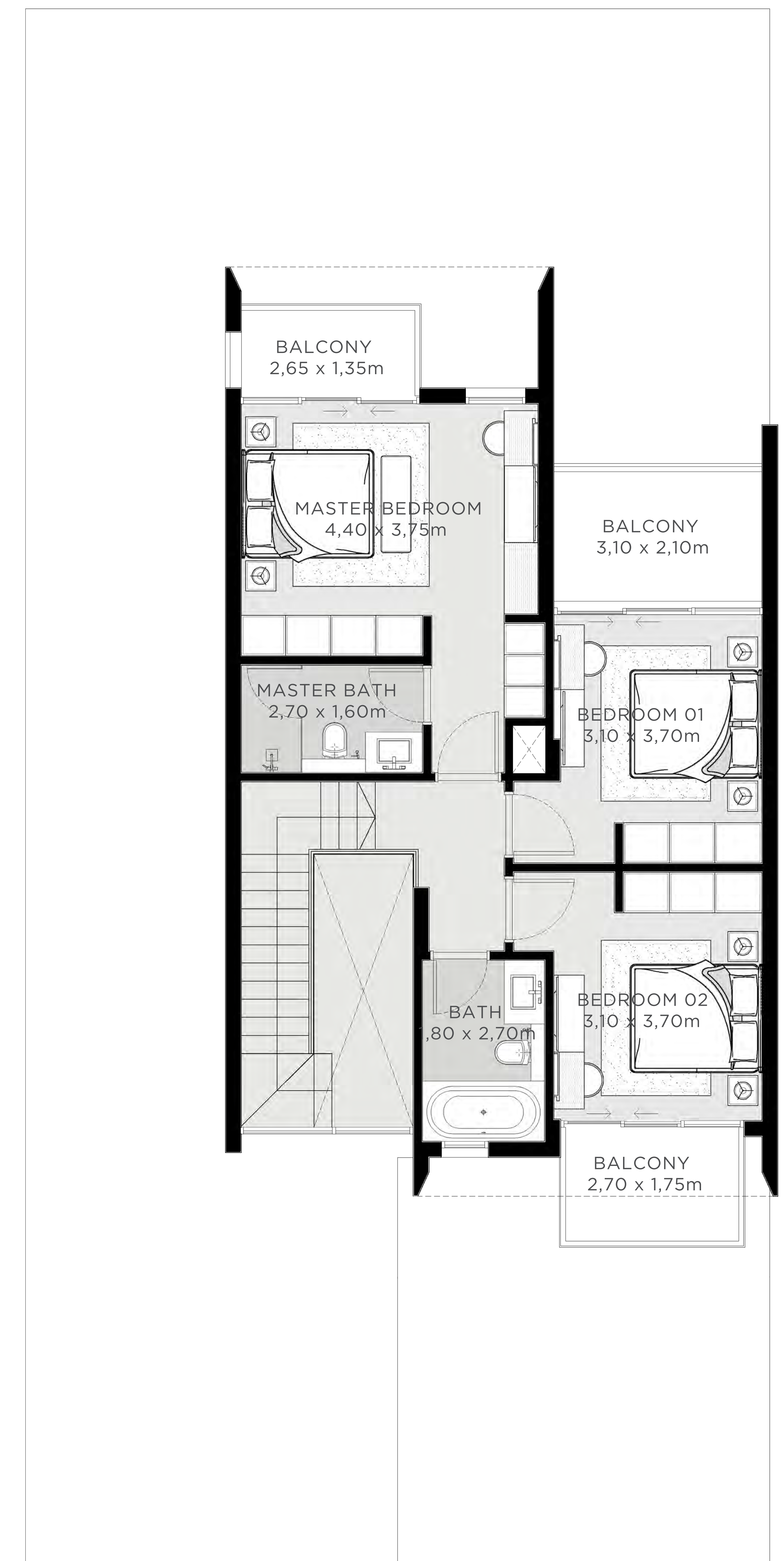

FIRST FLOOR

FLOOR PLAN 1. All dimensions are in imperial and metric, and measured from finish to finish excluding construction tolerances. 2. All materials, dimensions, and drawings are approximate only. 3. Information is subject to change without notice, at developer's absolute discretion. 4. Actual area may vary from the stated area. 5. Drawings not to scale. 6. All images used are for illustrative purposes only and do not represent the actual size, features, specifications, fittings, and furnishings. 7. The developer reserves the right to make revisions / alterations, at it's absolute discretion, without any liability whatsoever.



THE VALLEY

EDEN

IRIS 4 BEDROOM I B

UNIT	TOTAL AREA	
6 PLEX - TH 06	2334.79 SQFT	216.91 SQM

KEY PLAN

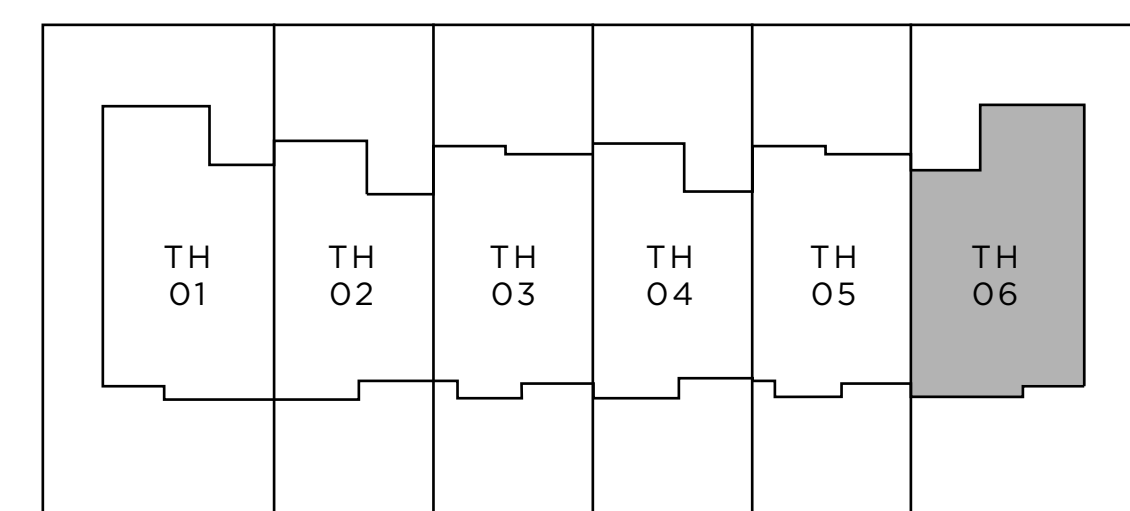

6 PLEX

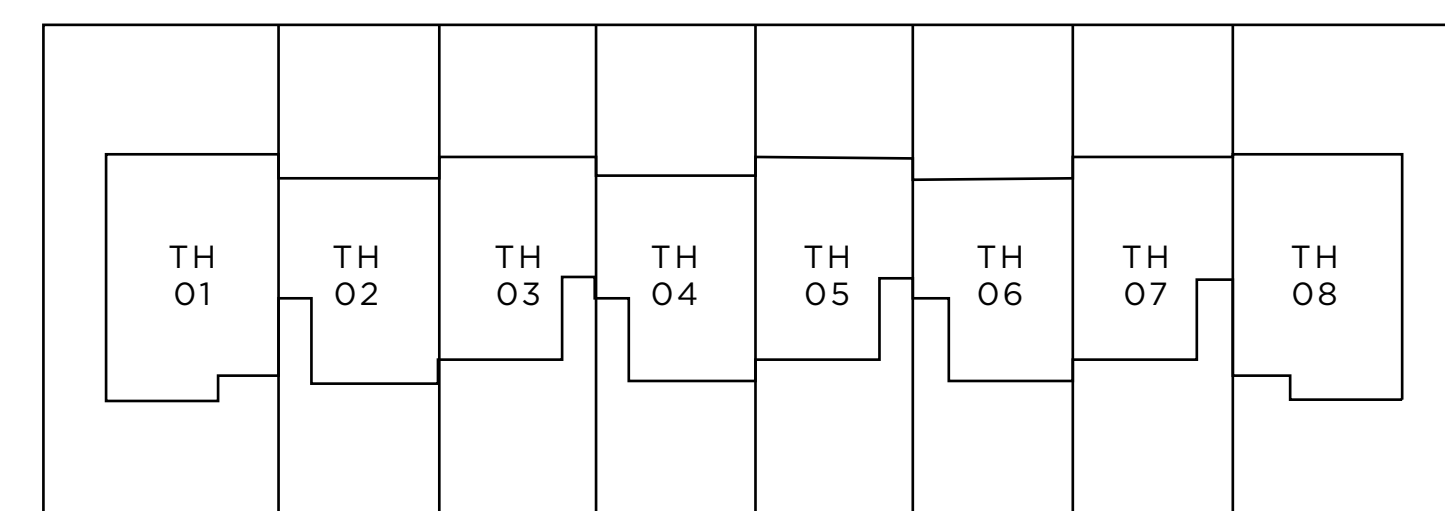

8 PLEX

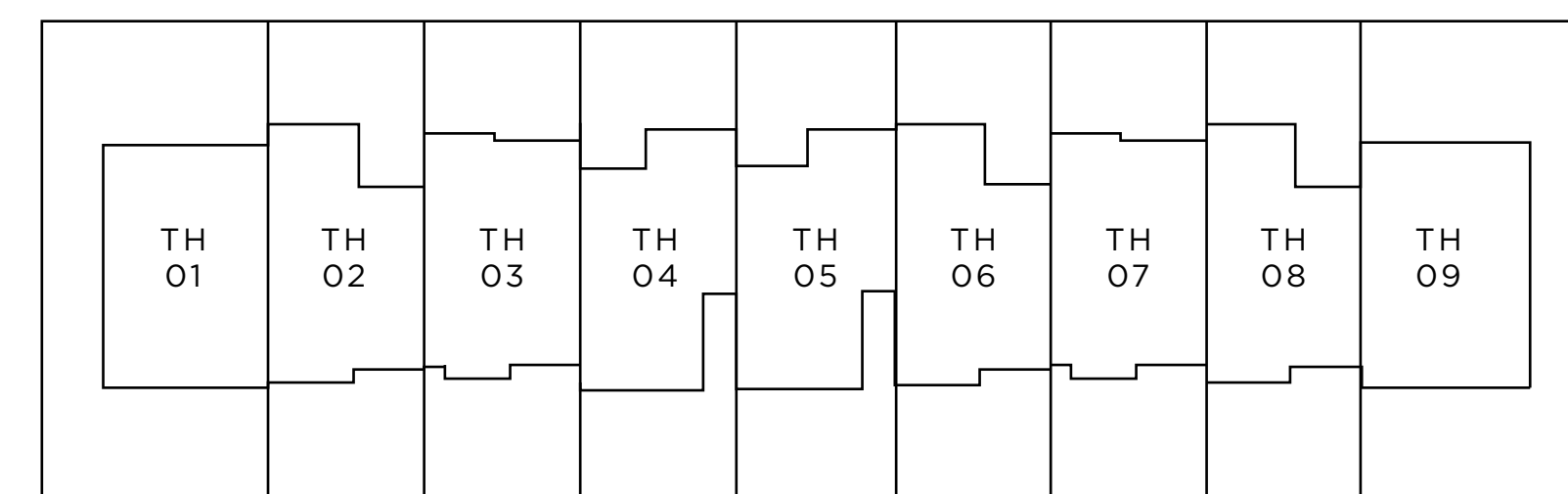

9 PLEX

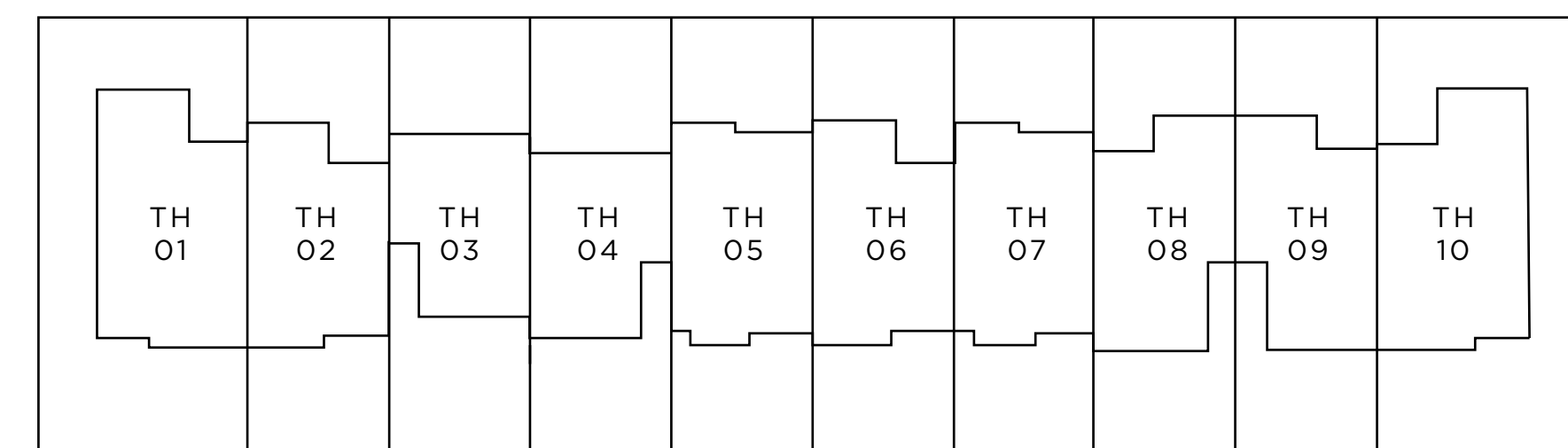

10 PLEX



GROUND FLOOR

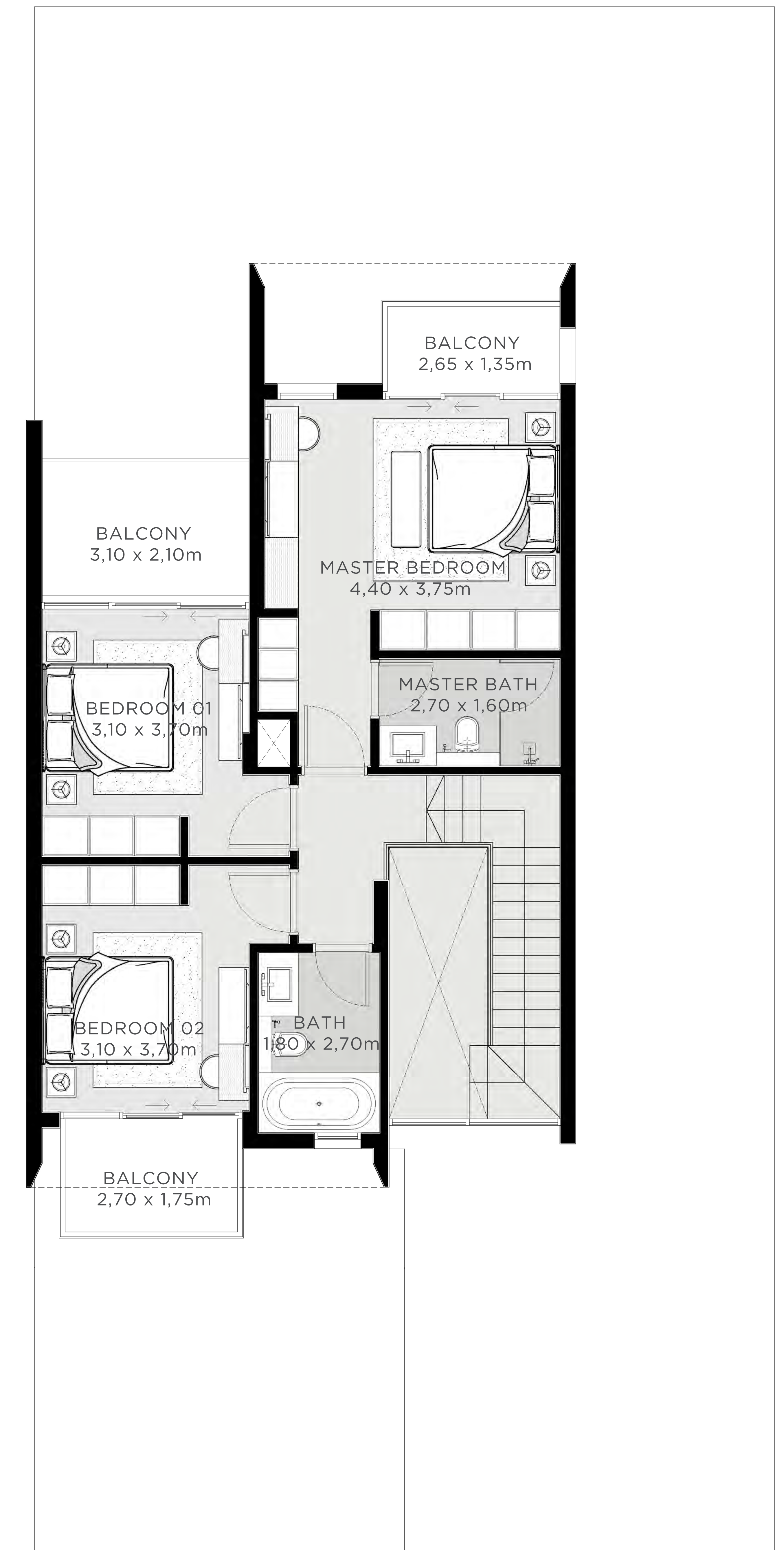

FIRST FLOOR

FLOOR PLAN 1. All dimensions are in imperial and metric, and measured from finish to finish excluding construction tolerances. 2. All materials, dimensions, and drawings are approximate only. 3. Information is subject to change without notice, at developer's absolute discretion. 4. Actual area may vary from the stated area. 5. Drawings not to scale. 6. All images used are for illustrative purposes only and do not represent the actual size, features, specifications, fittings, and furnishings. 7. The developer reserves the right to make revisions / alterations, at it's absolute discretion, without any liability whatsoever.

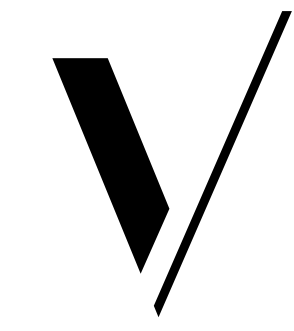

THE VALLEY

EDEN

IRIS 4 BEDROOM I C

UNIT	TOTAL AREA
10 PLEX - TH 10	2336.73 SQFT 217.09 SQM

KEY PLAN

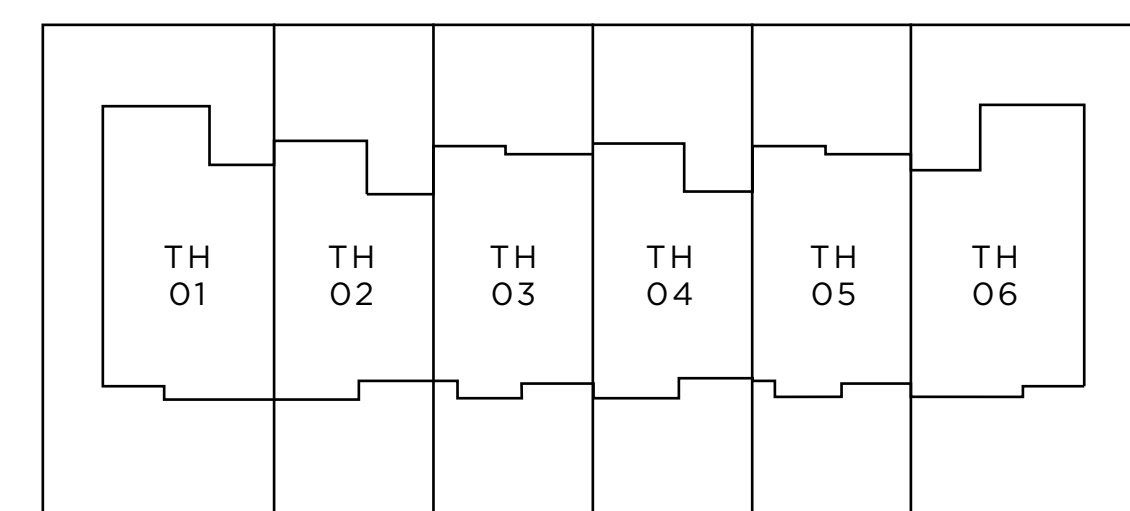

6 PLEX

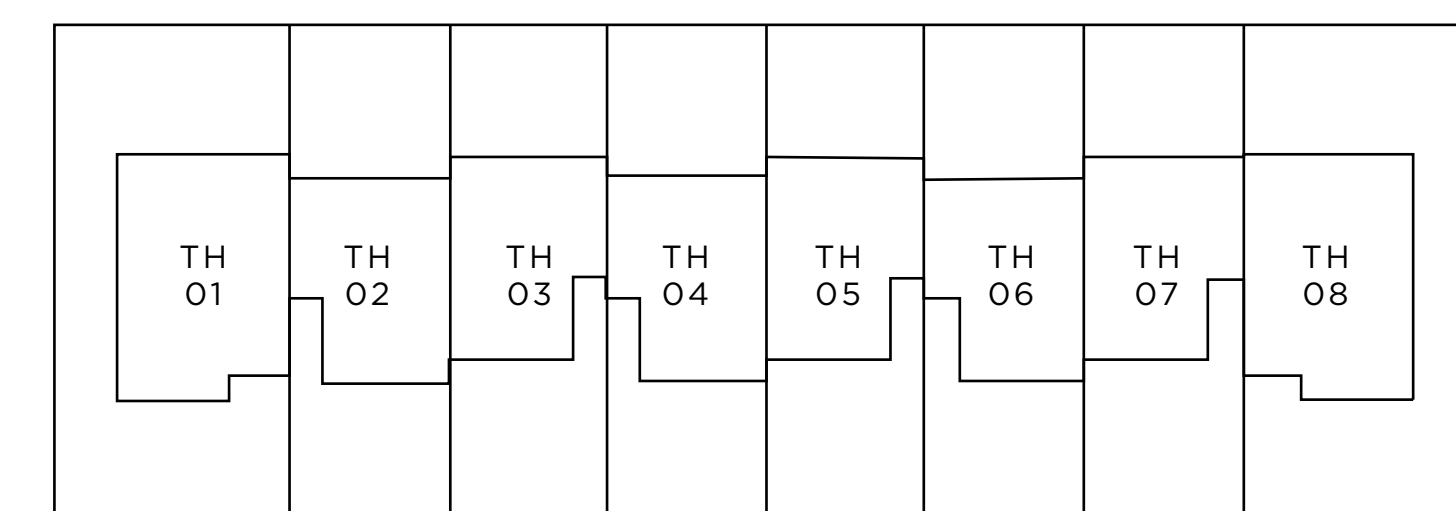

8 PLEX

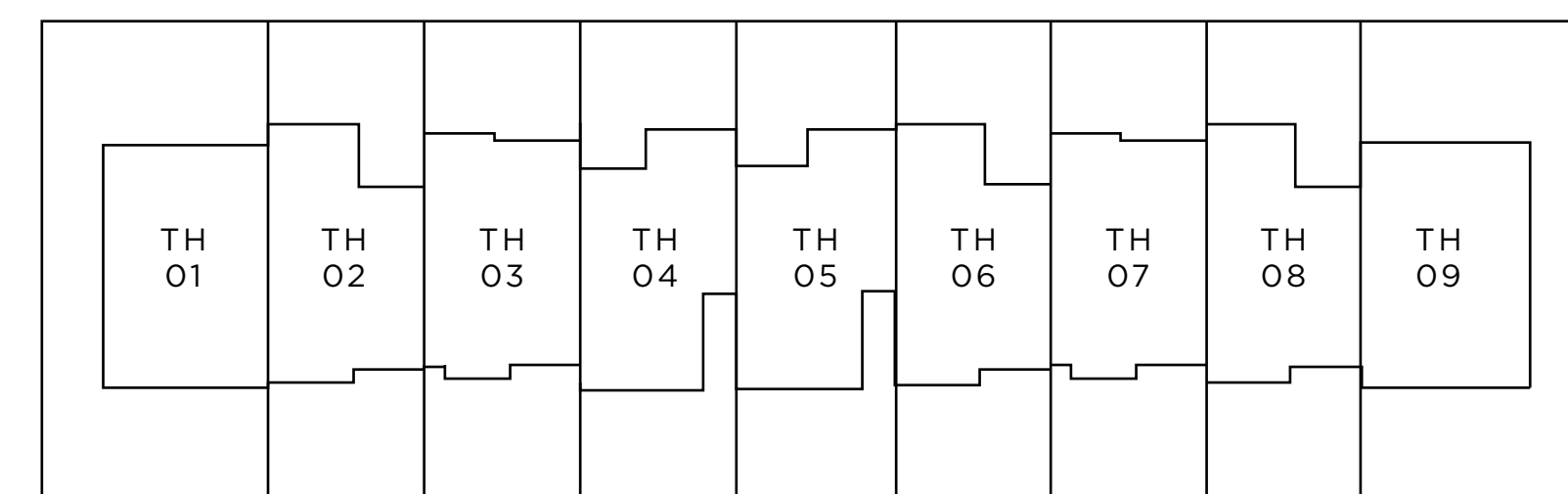

9 PLEX

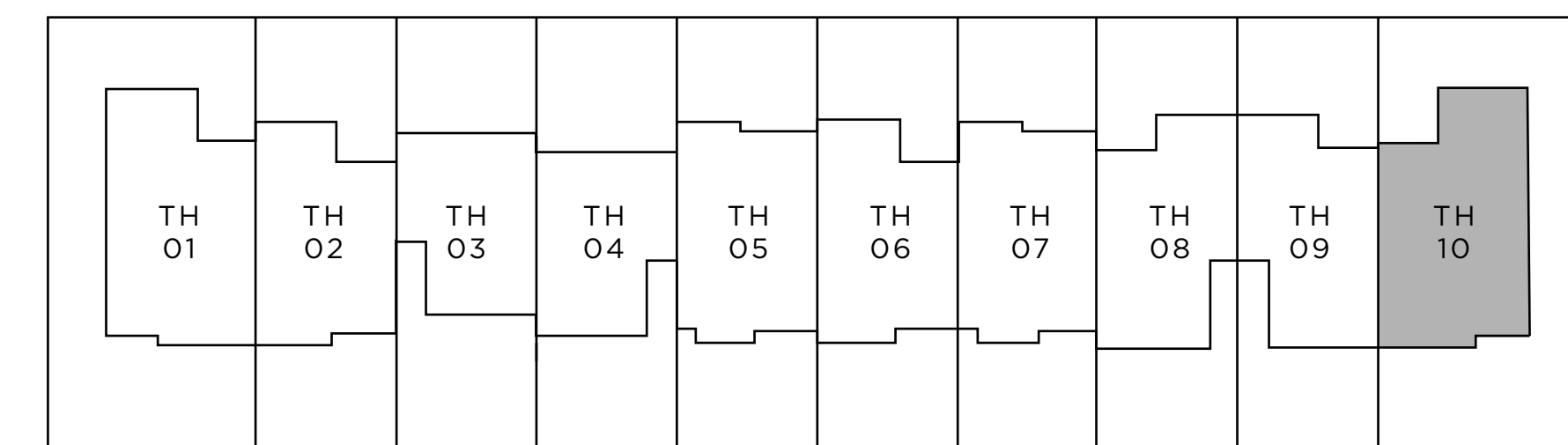

10 PLEX

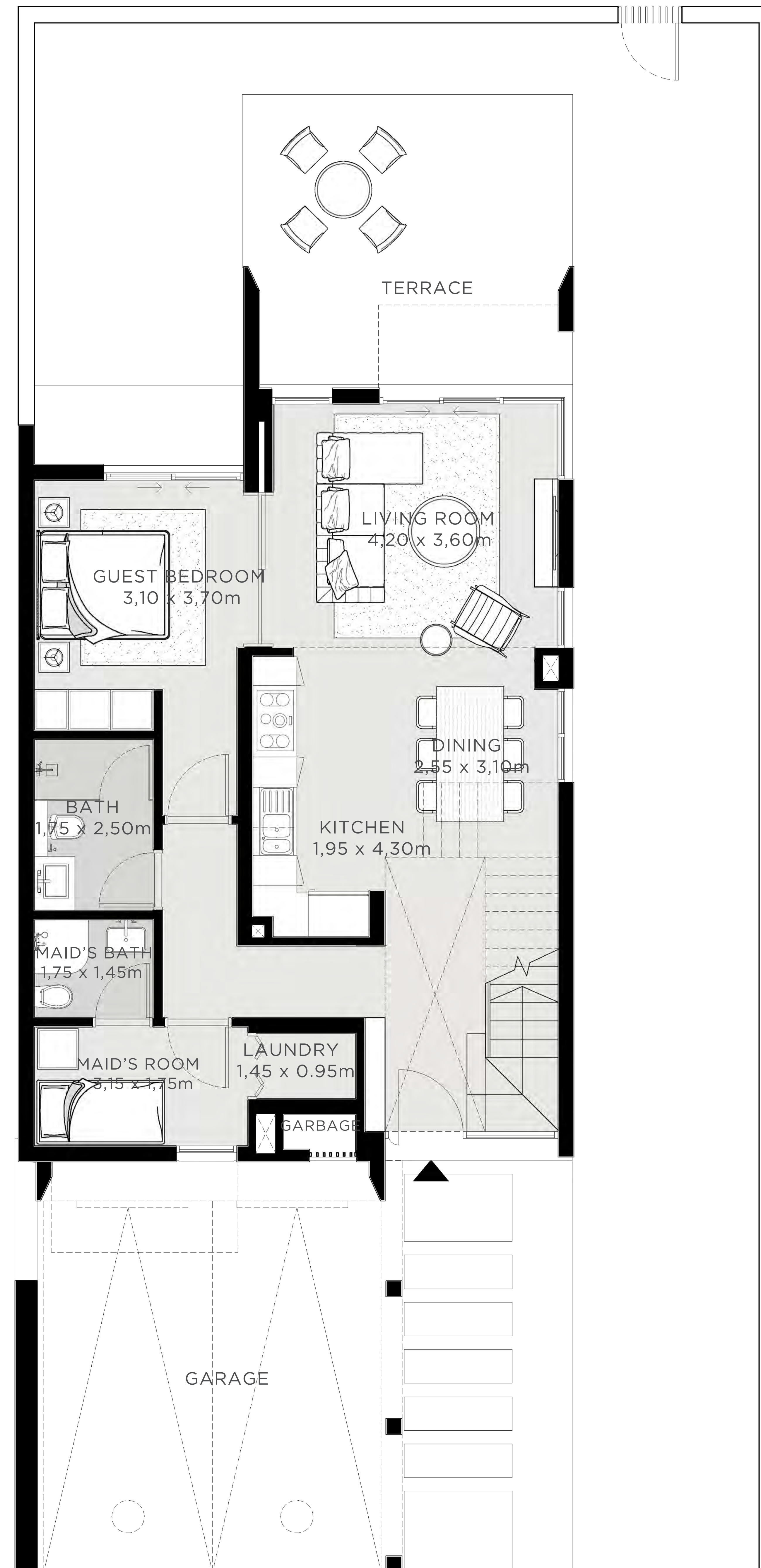

GROUND FLOOR

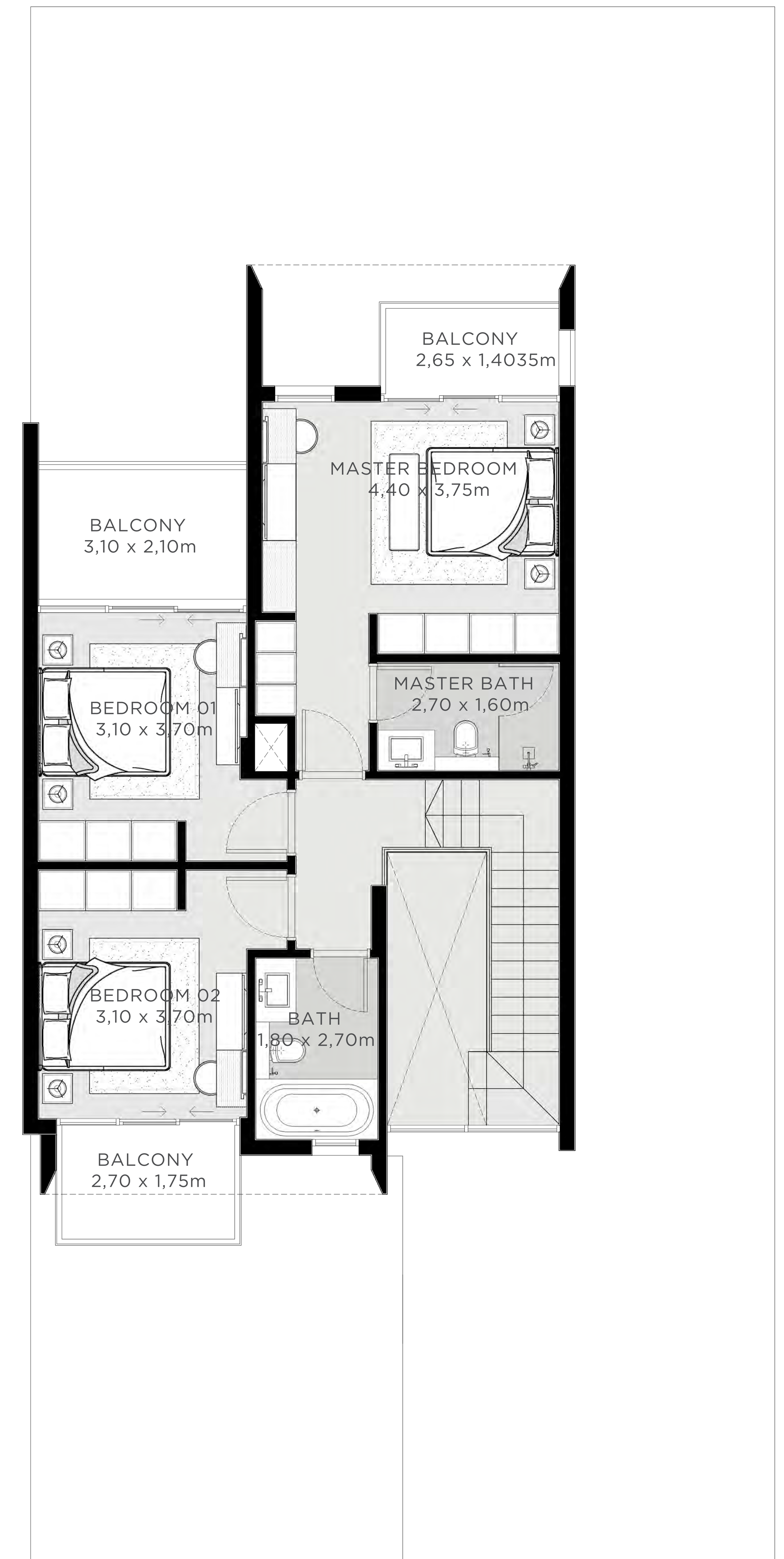

FIRST FLOOR

FLOOR PLAN 1. All dimensions are in imperial and metric, and measured from finish to finish excluding construction tolerances. 2. All materials, dimensions, and drawings are approximate only. 3. Information is subject to change without notice, at developer's absolute discretion. 4. Actual area may vary from the stated area. 5. Drawings not to scale. 6. All images used are for illustrative purposes only and do not represent the actual size, features, specifications, fittings, and furnishings. 7. The developer reserves the right to make revisions / alterations, at it's absolute discretion, without any liability whatsoever.

V
THE VALLEY

EDEN

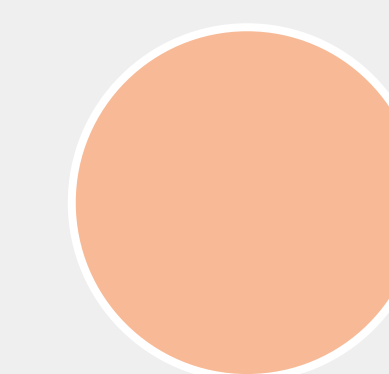

MAY BELL



FLOOR PLAN 1. All dimensions are in imperial and metric, and measured from finish to finish excluding construction tolerances. 2. All materials, dimensions, and drawings are approximate only. 3. Information is subject to change without notice, at developer's absolute discretion. 4. Actual area may vary from the stated area. 5. Drawings not to scale. 6. All images used are for illustrative purposes only and do not represent the actual size, features, specifications, fittings, and furnishings. 7. The developer reserves the right to make revisions / alterations, at it's absolute discretion, without any liability whatsoever.

V
THE VALLEY

EDEN

MAYBELL
3 BEDROOM 1 A

UNIT	TOTAL AREA	
9 PLEX - TH 04	2040.94 SQFT	189.61 SQM
9 PLEX - TH 05	2066.13 SQFT	191.95 SQM
10 PLEX - TH 08	2028.13 SQFT	188.42 SQM

KEY PLAN

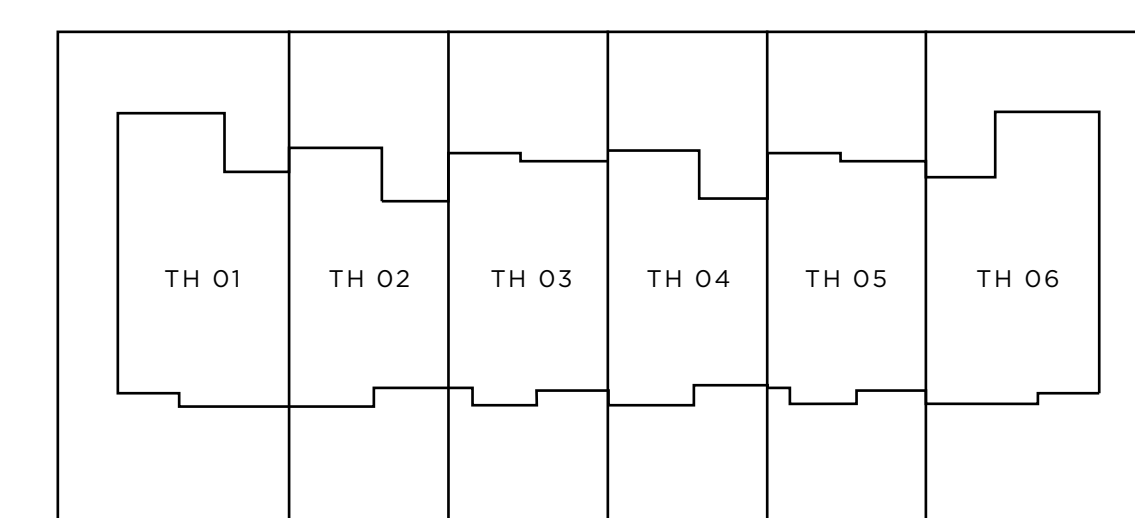

6 PLEX
STREET SIDE

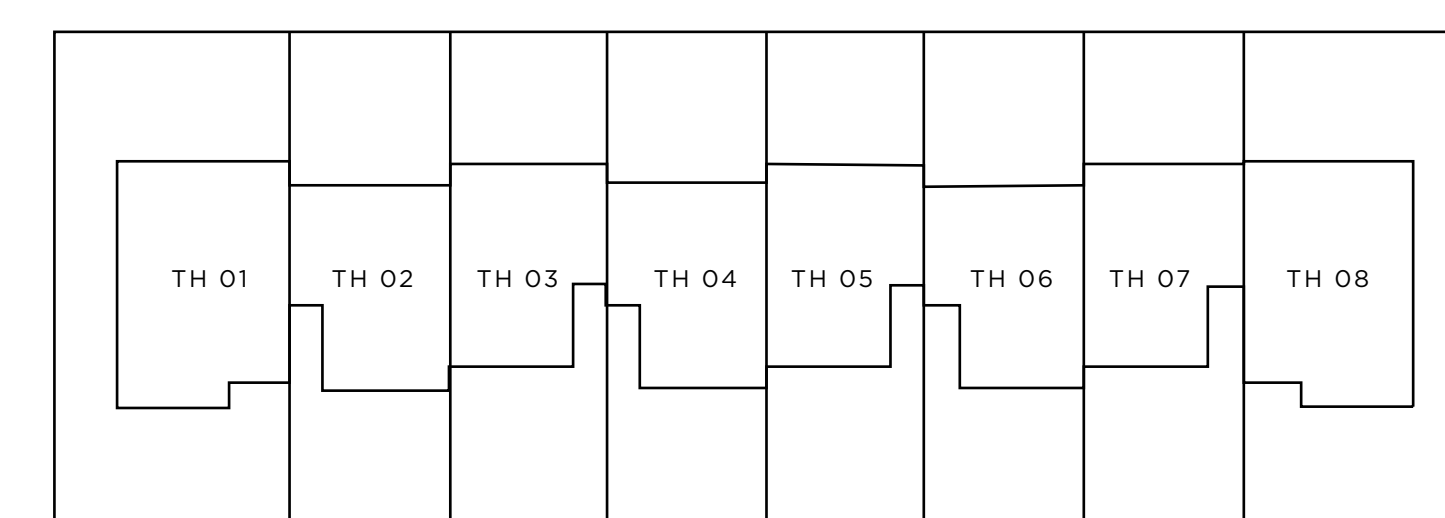

8 PLEX
STREET SIDE

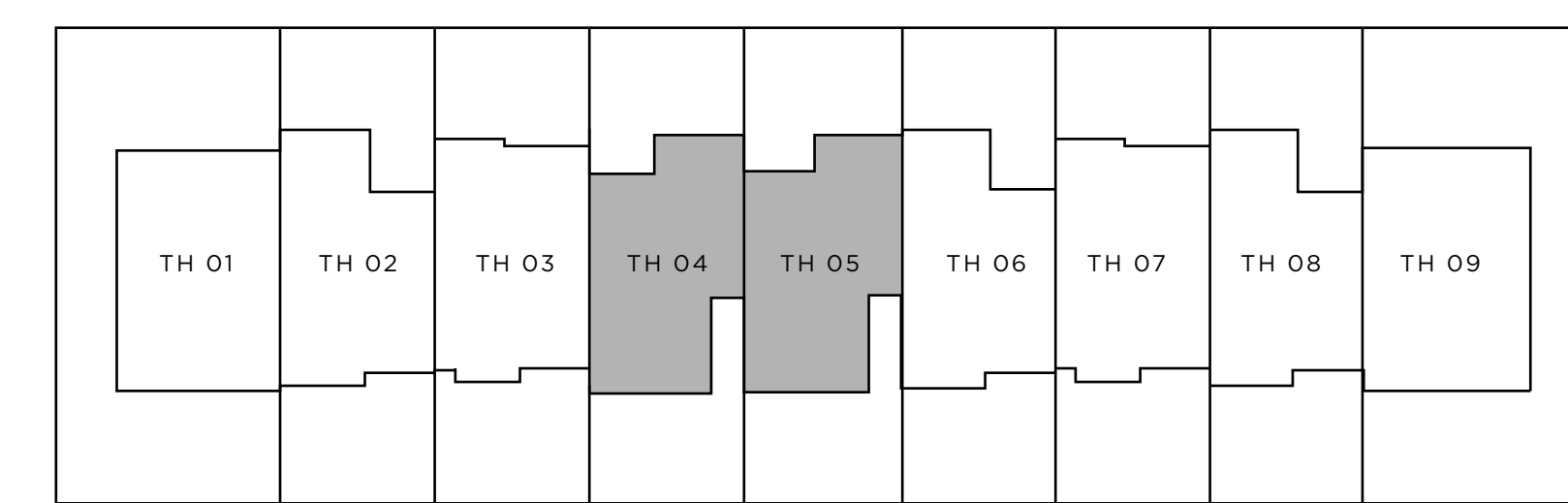

9 PLEX
STREET SIDE

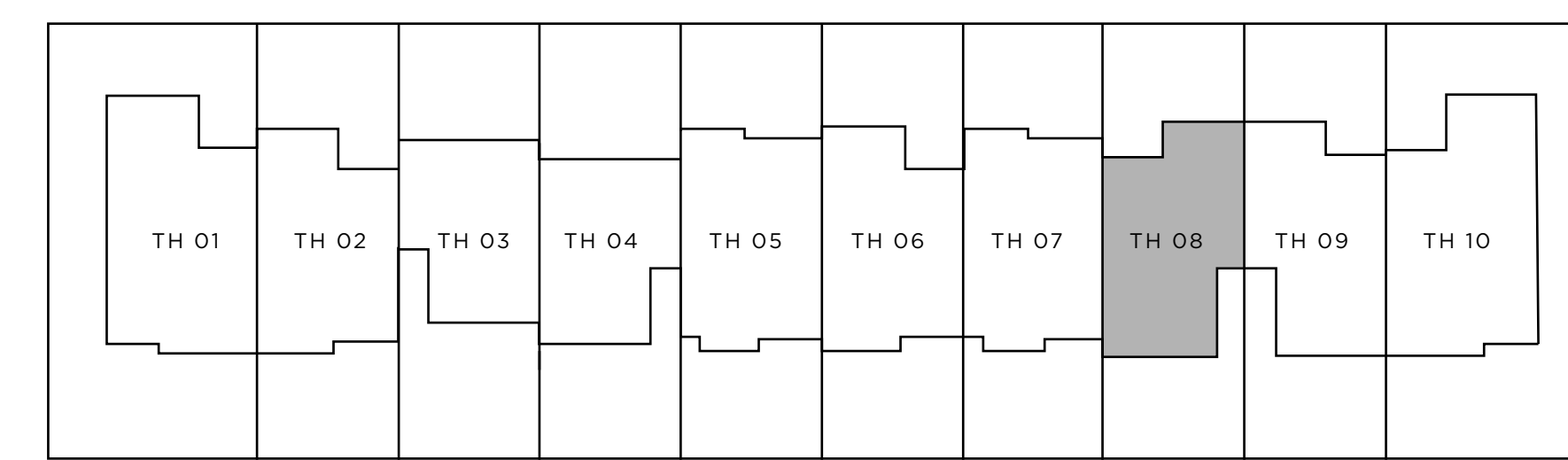

10 PLEX
STREET SIDE

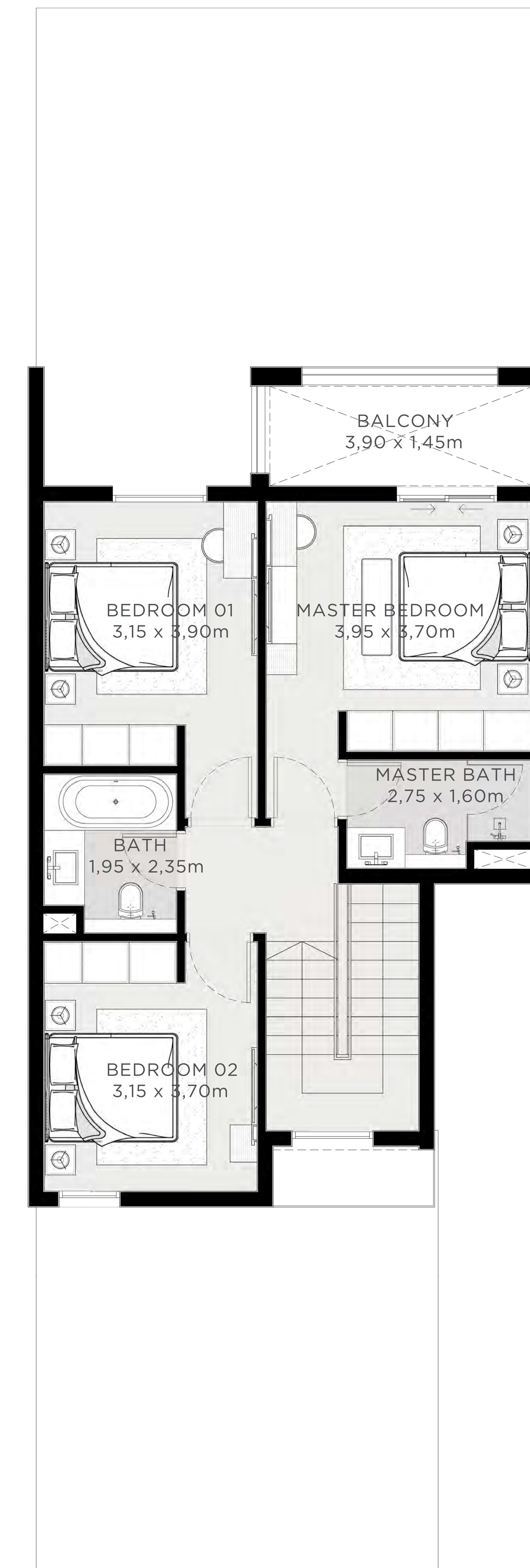
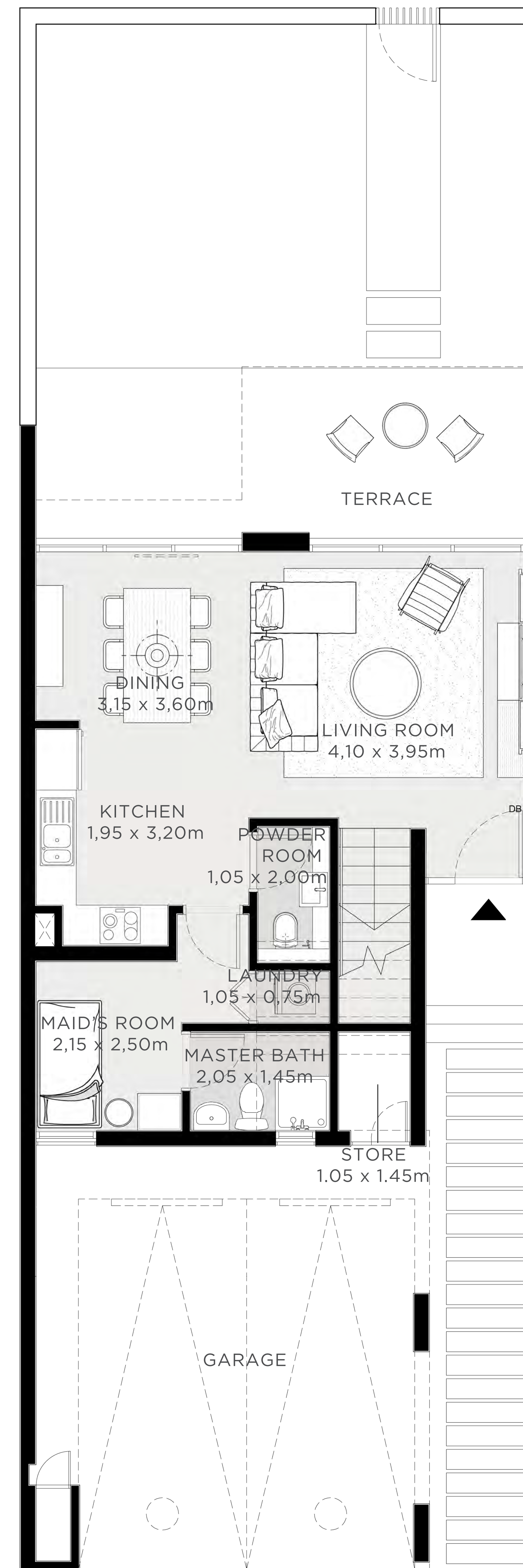

FLOOR PLAN 1. All dimensions are in imperial and metric, and measured from finish to finish excluding construction tolerances. 2. All materials, dimensions, and drawings are approximate only. 3. Information is subject to change without notice, at developer's absolute discretion. 4. Actual area may vary from the stated area. 5. Drawings not to scale. 6. All images used are for illustrative purposes only and do not represent the actual size, features, specifications, fittings, and furnishings. 7. The developer reserves the right to make revisions / alterations, at it's absolute discretion, without any liability whatsoever.

V
THE VALLEY

EDEN

MAYBELL
3 BEDROOM I B

UNIT	TOTAL AREA	
10 PLEX - TH 09	2028.13 SQFT	188.42 SQM

KEY PLAN

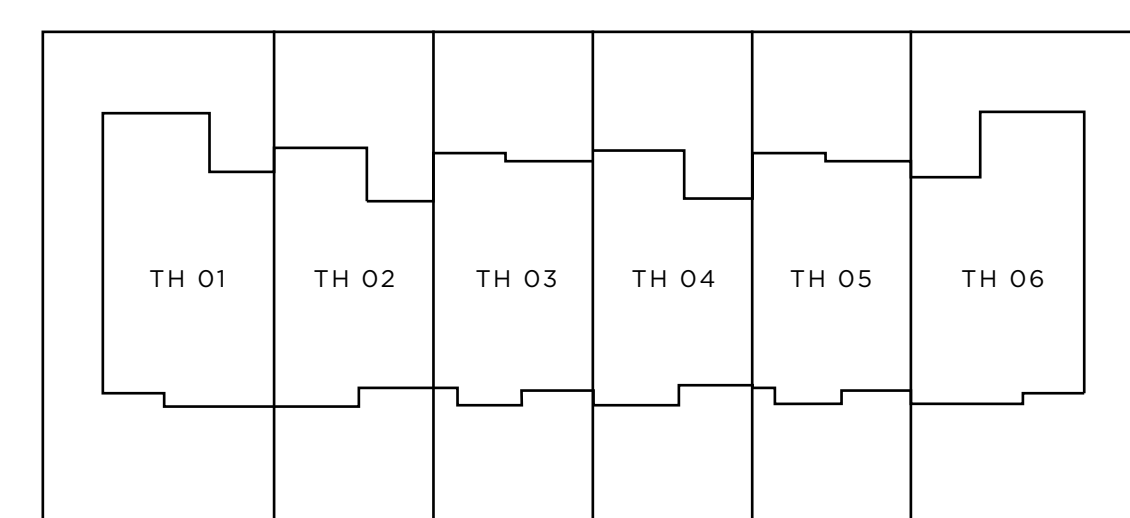

6 PLEX
 STREET SIDE

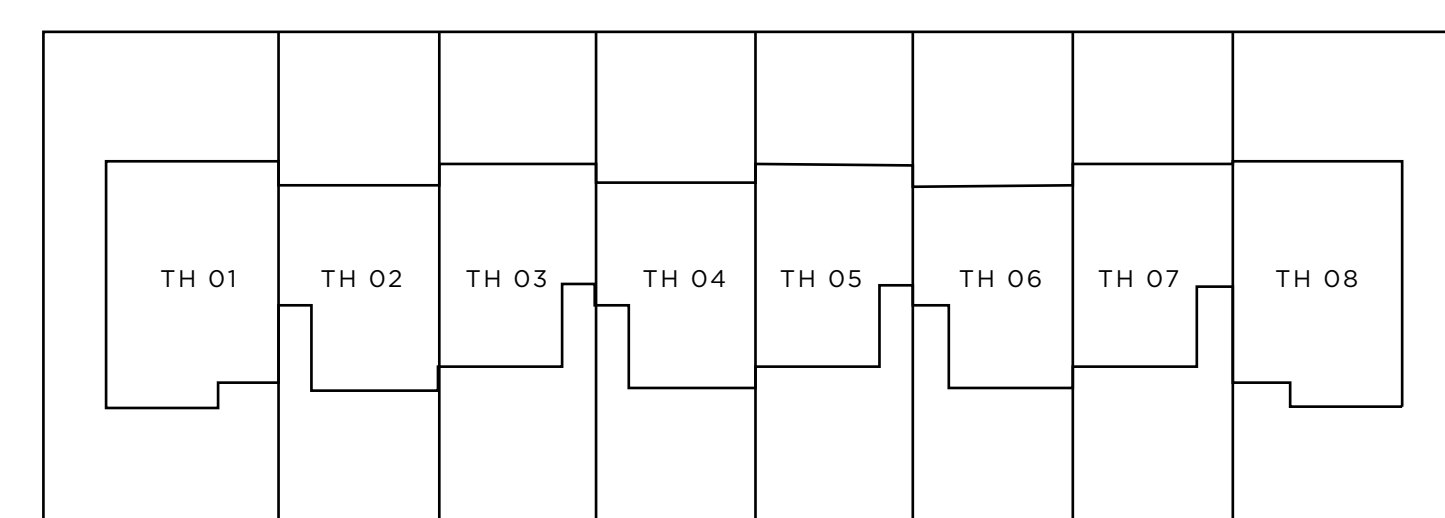

8 PLEX
 STREET SIDE

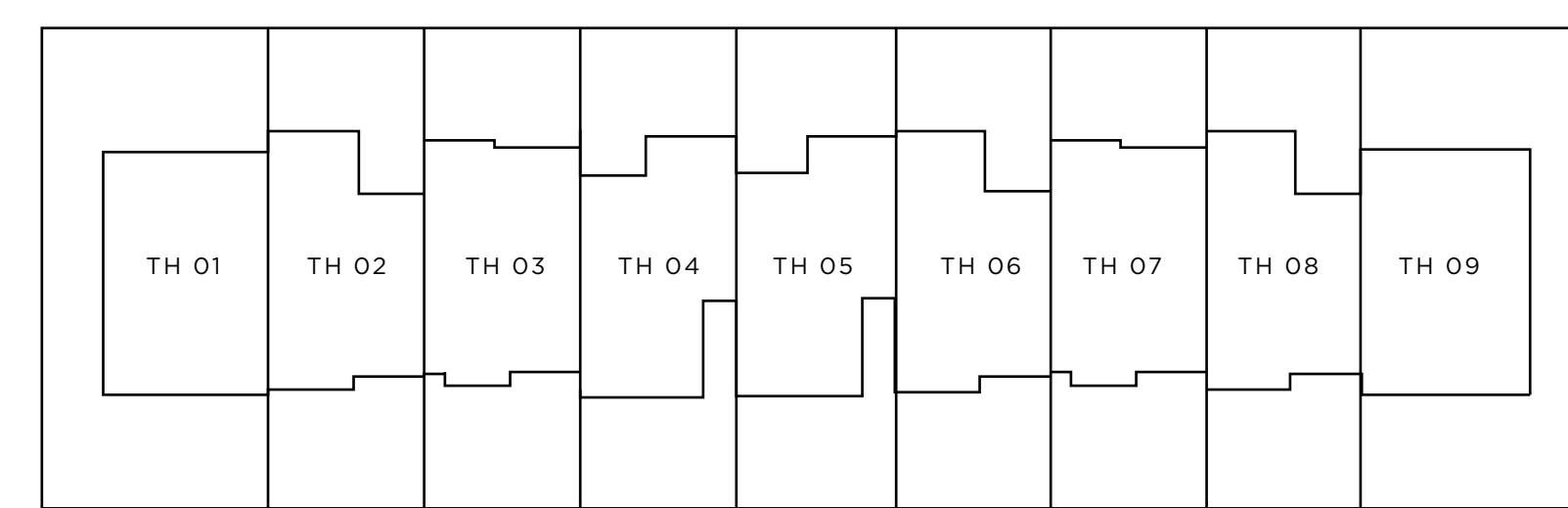

9 PLEX
 STREET SIDE

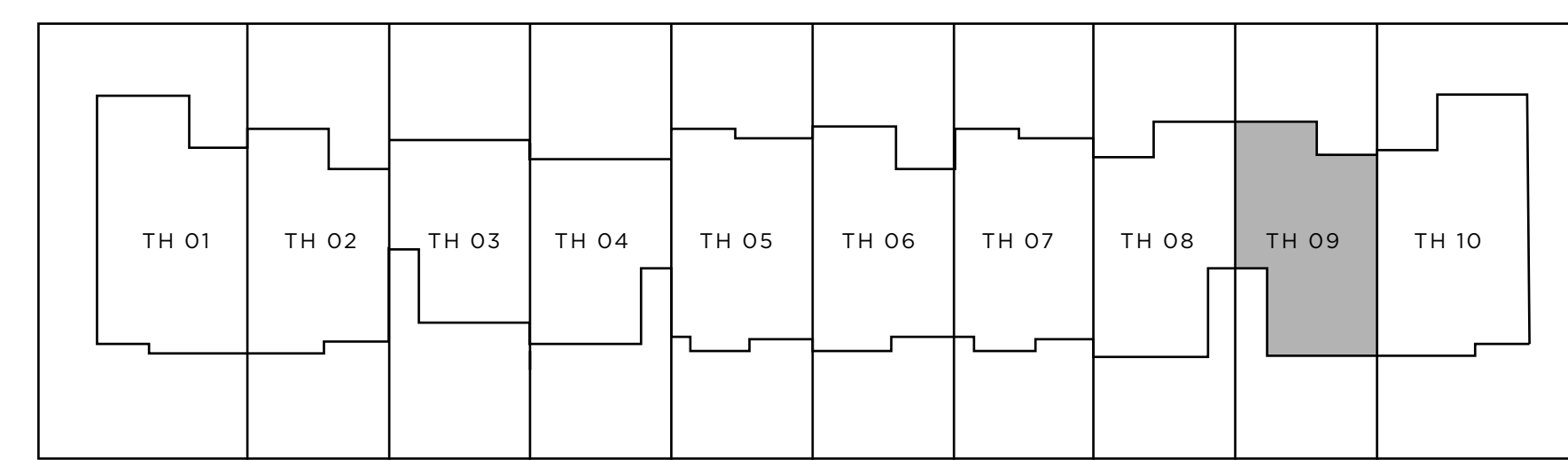

10 PLEX
 STREET SIDE

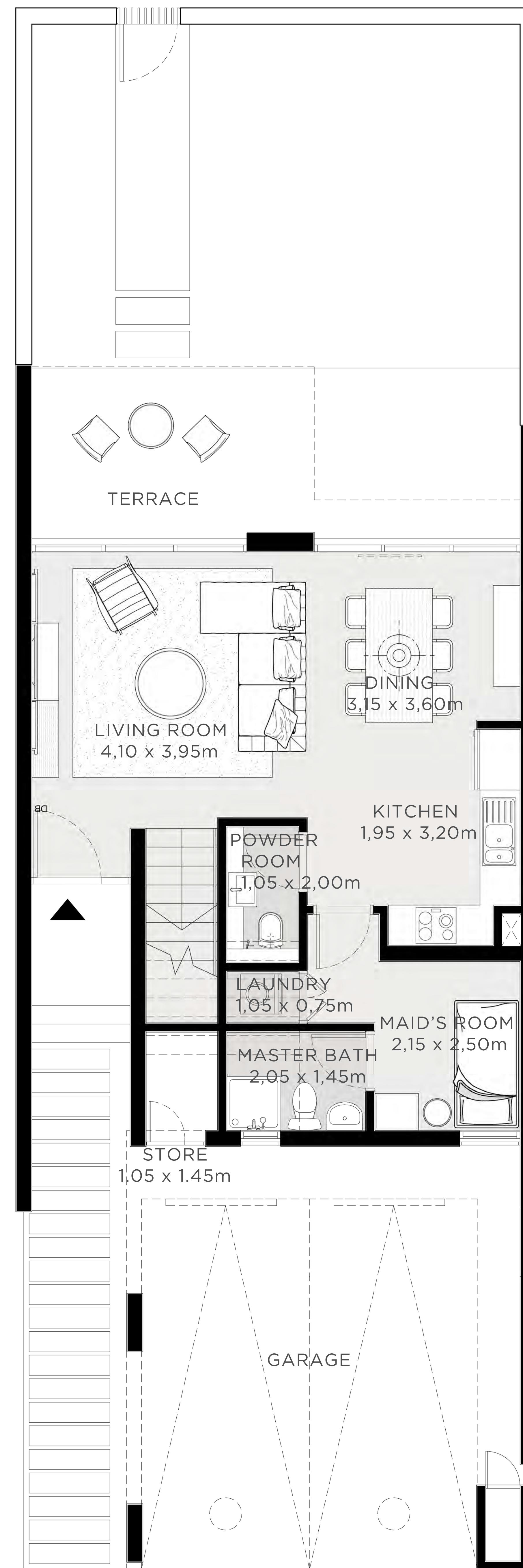

GROUND FLOOR



FIRST FLOOR

FLOOR PLAN 1. All dimensions are in imperial and metric, and measured from finish to finish excluding construction tolerances. 2. All materials, dimensions, and drawings are approximate only. 3. Information is subject to change without notice, at developer's absolute discretion. 4. Actual area may vary from the stated area. 5. Drawings not to scale. 6. All images used are for illustrative purposes only and do not represent the actual size, features, specifications, fittings, and furnishings. 7. The developer reserves the right to make revisions / alterations, at it's absolute discretion, without any liability whatsoever.

THE VALLEY

EDEN

MAYBELL
4 BEDROOM 1A

UNIT	TOTAL AREA	
9 PLEX - TH 01	2311.11 SQFT	214.71 SQM

KEY PLAN

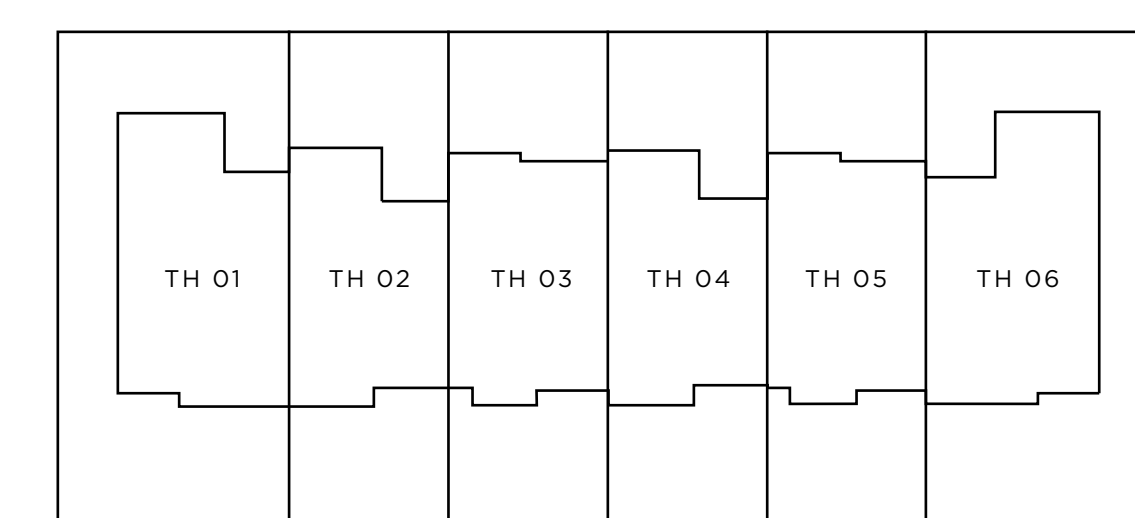

6 PLEX

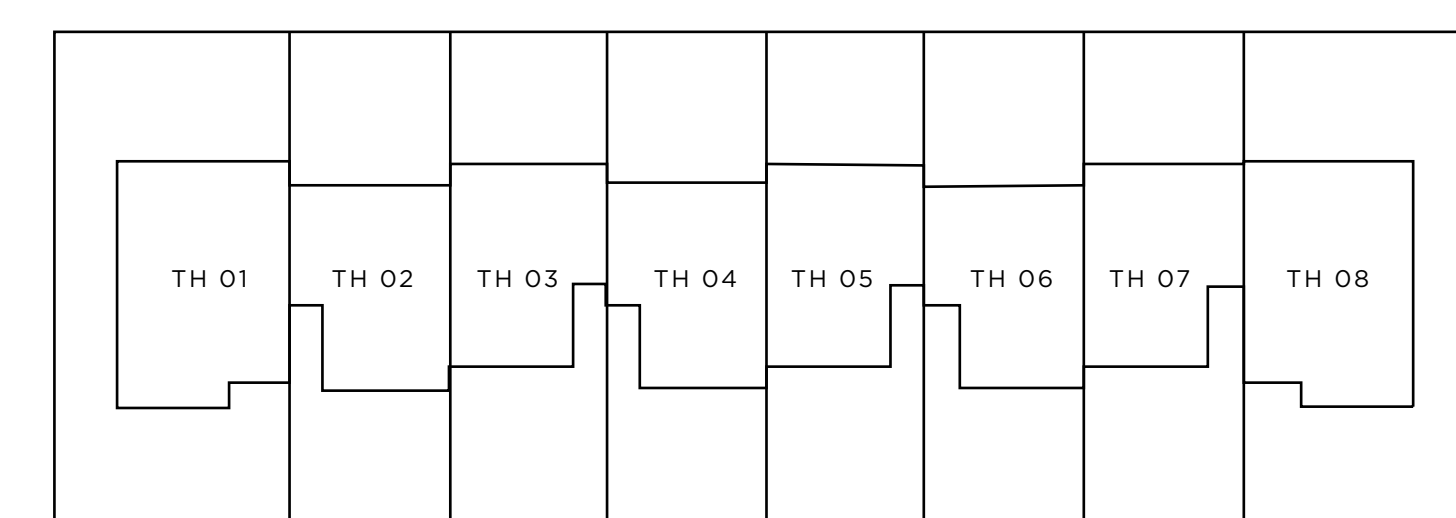

8 PLEX

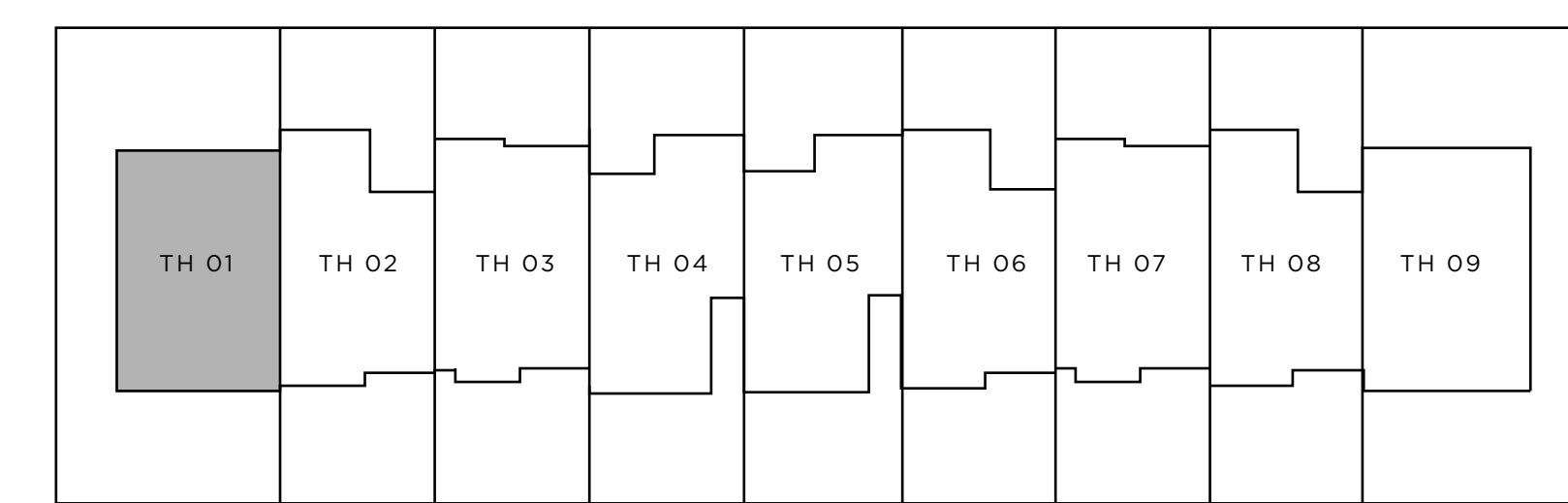

9 PLEX

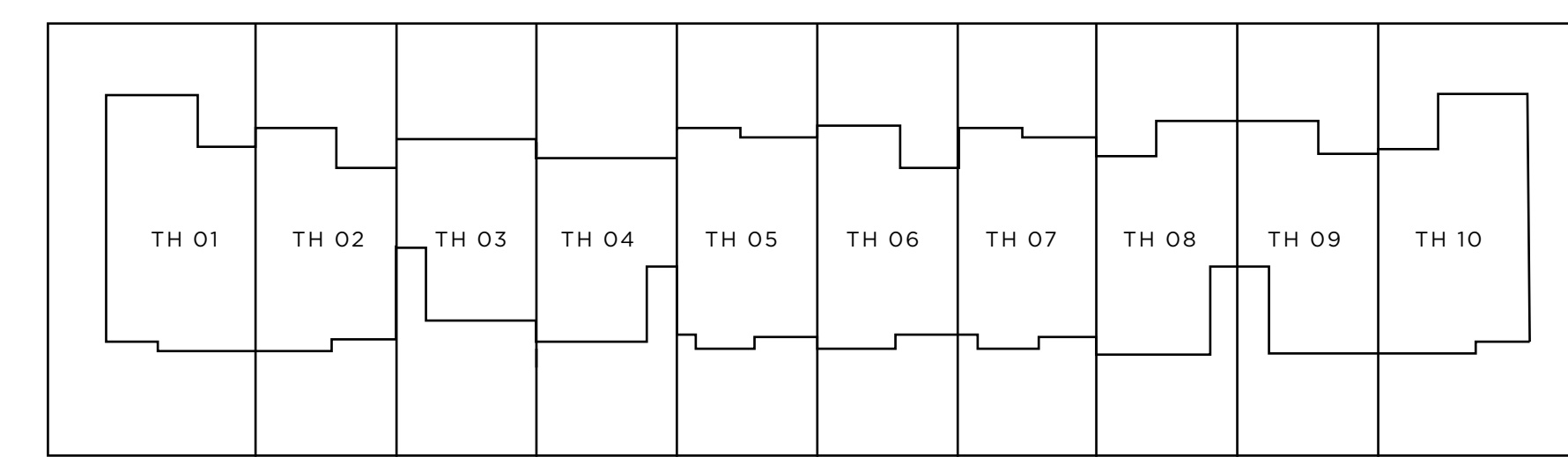

10 PLEX

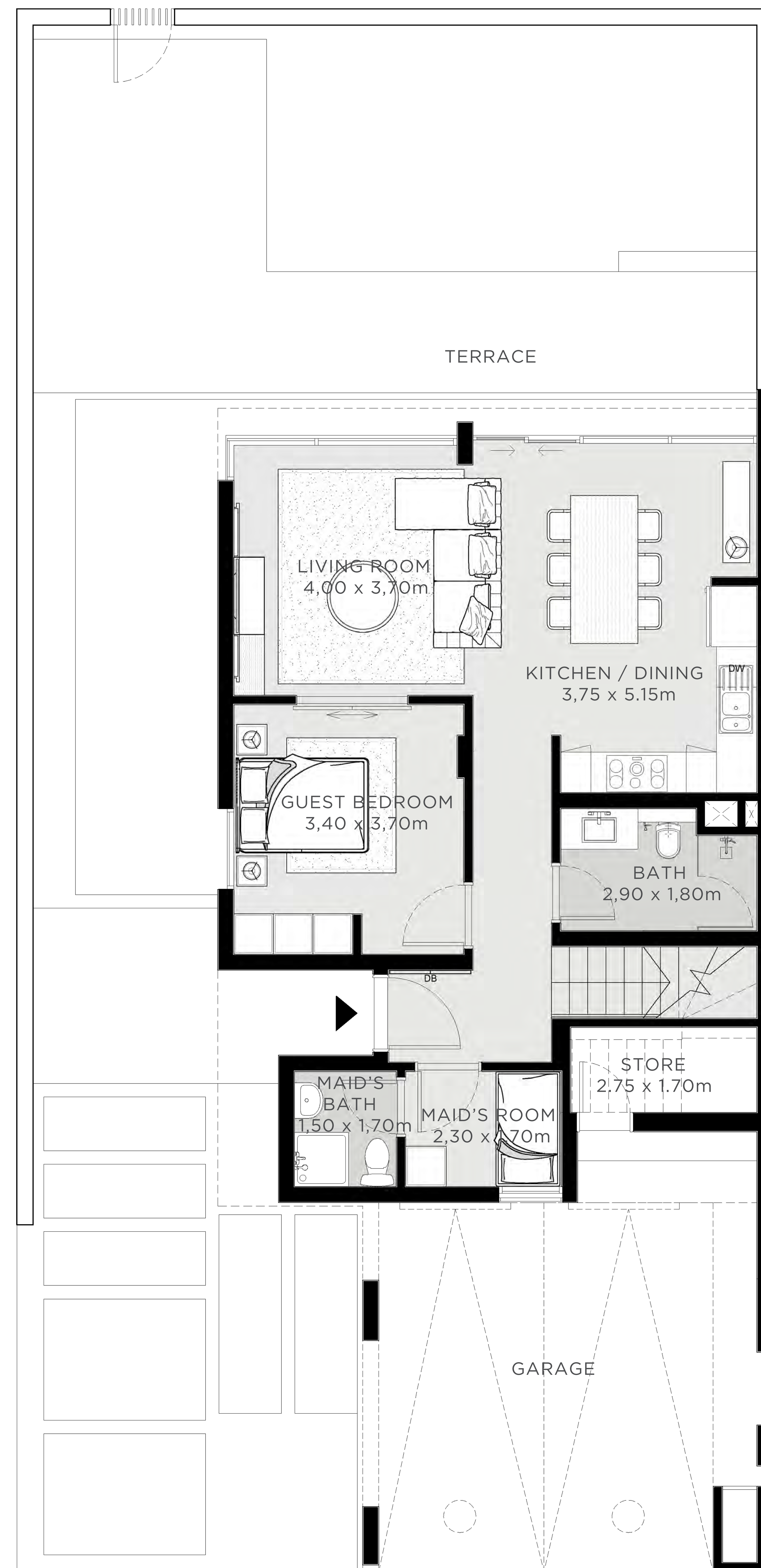

GROUND FLOOR

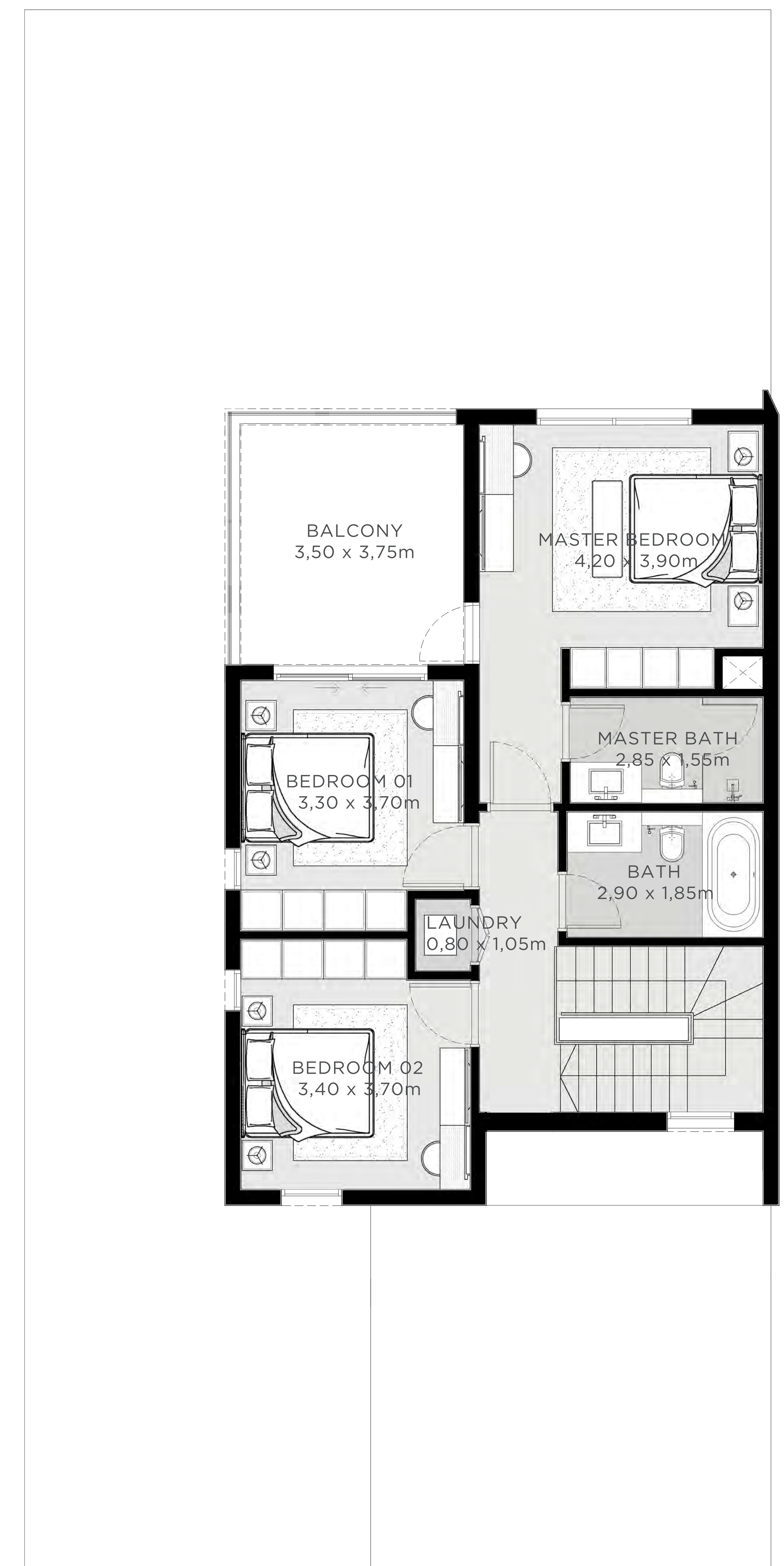

FIRST FLOOR

FLOOR PLAN 1. All dimensions are in imperial and metric, and measured from finish to finish excluding construction tolerances. 2. All materials, dimensions, and drawings are approximate only. 3. Information is subject to change without notice, at developer's absolute discretion. 4. Actual area may vary from the stated area. 5. Drawings not to scale. 6. All images used are for illustrative purposes only and do not represent the actual size, features, specifications, fittings, and furnishings. 7. The developer reserves the right to make revisions / alterations, at it's absolute discretion, without any liability whatsoever.

THE VALLEY

EDEN

MAYBELL
4 BEDROOM I B

UNIT	TOTAL AREA	
9 PLEX - TH 09	2310.68 SQFT	214.67 SQM

KEY PLAN

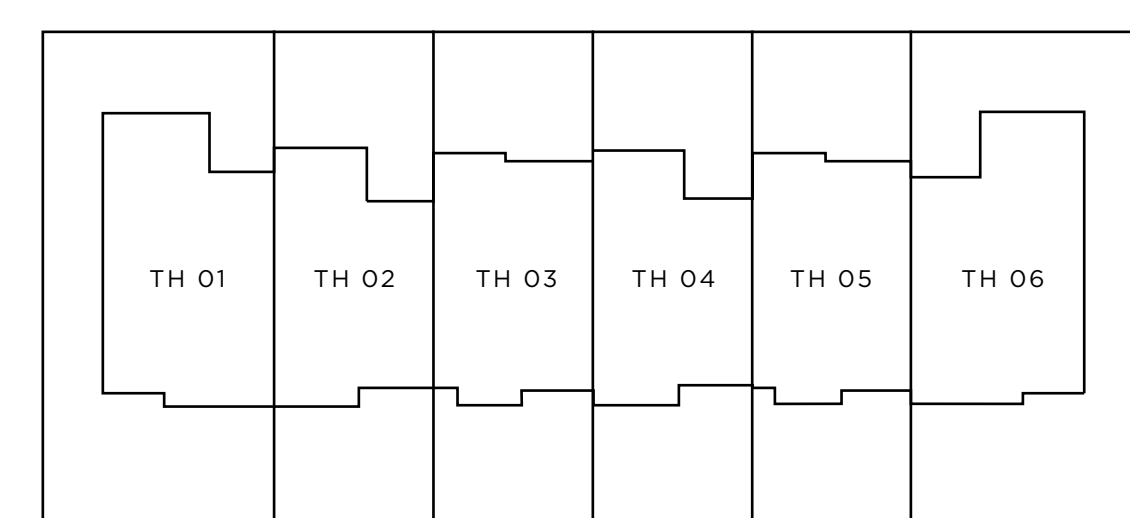

6 PLEX

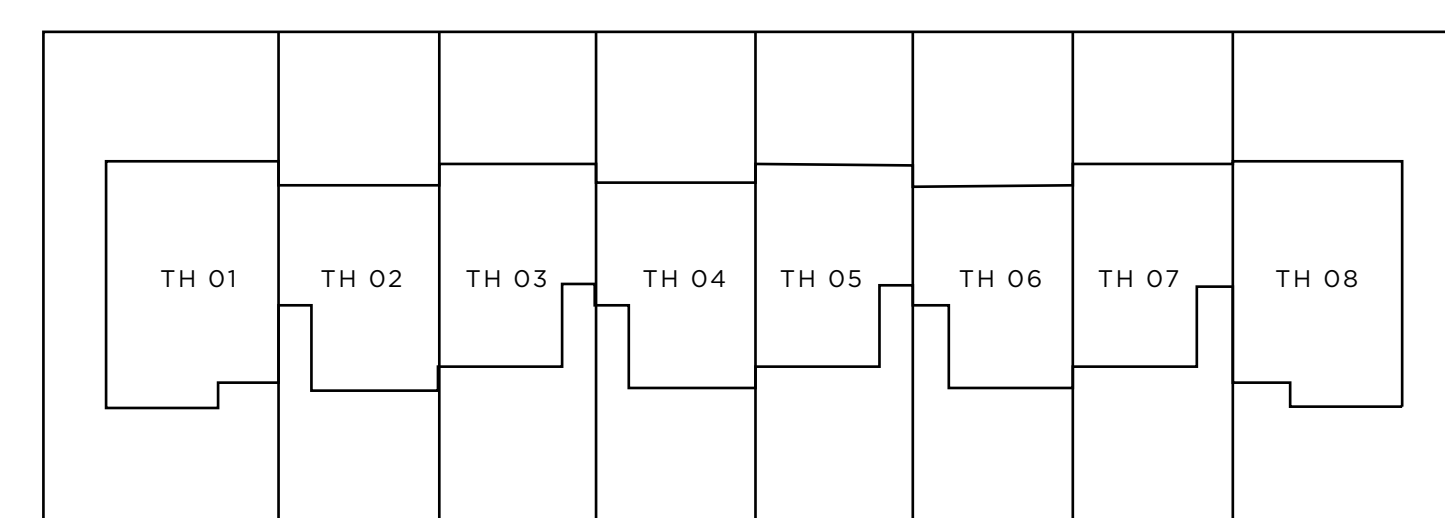

8 PLEX

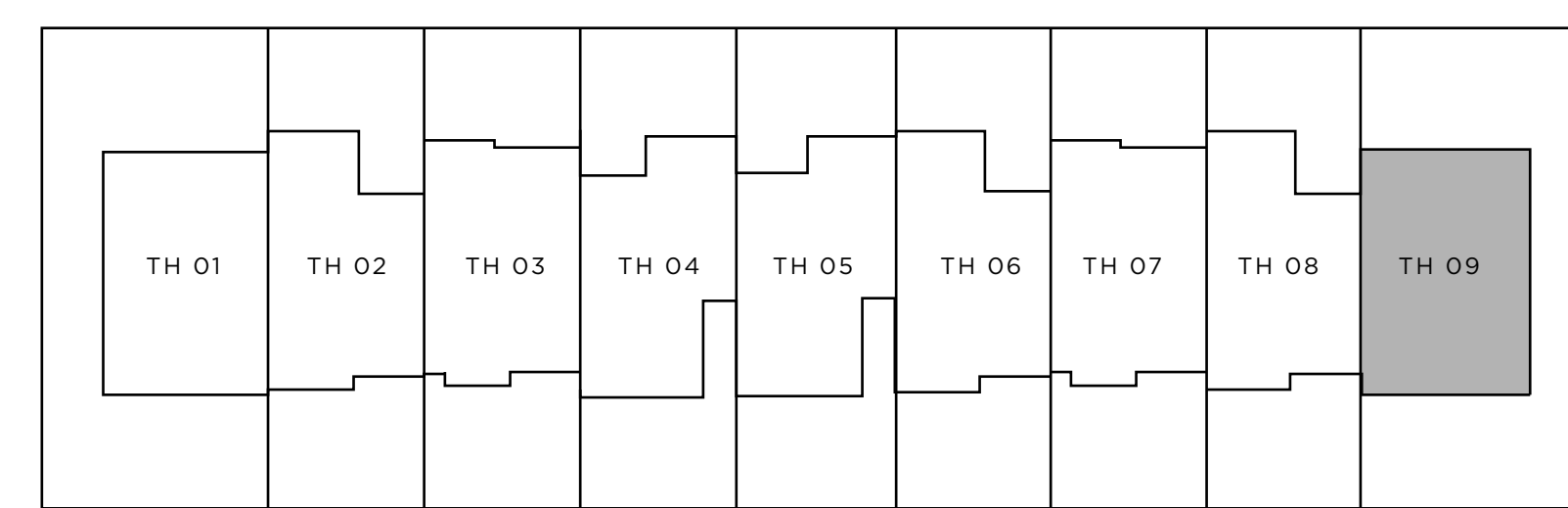

9 PLEX

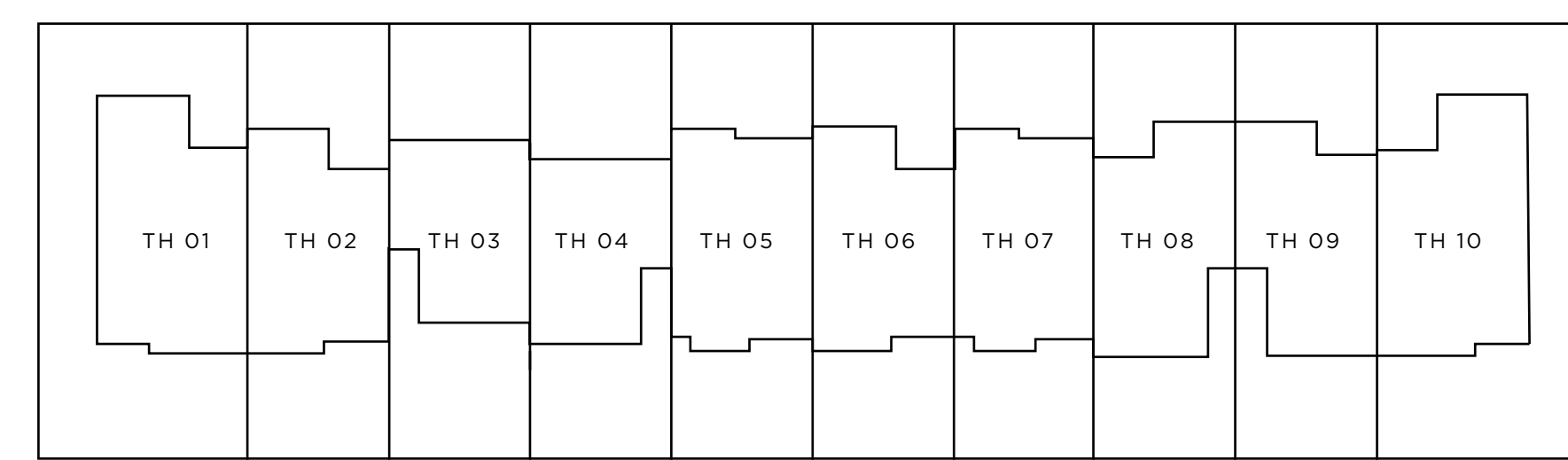

10 PLEX

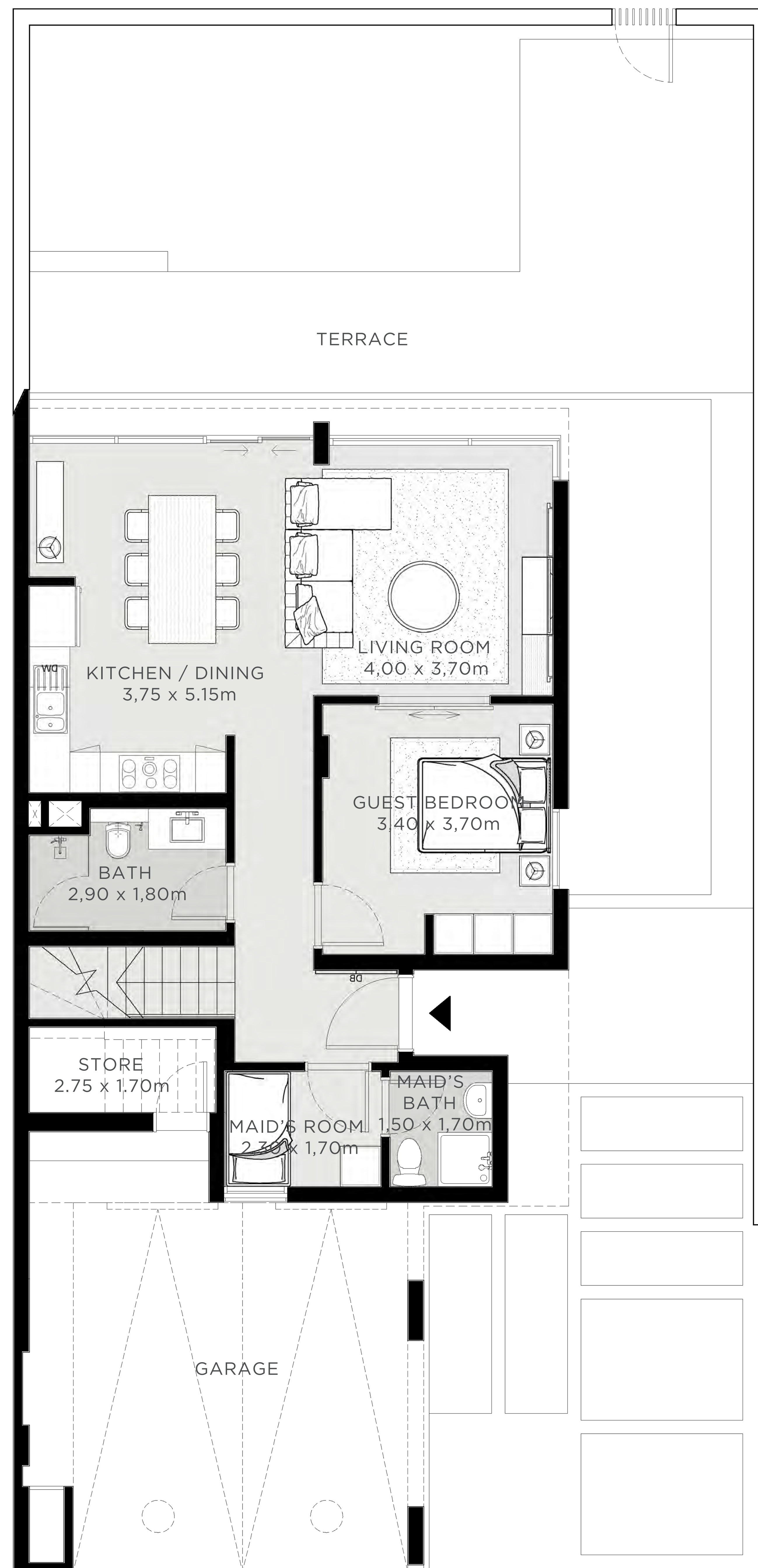

GROUND FLOOR

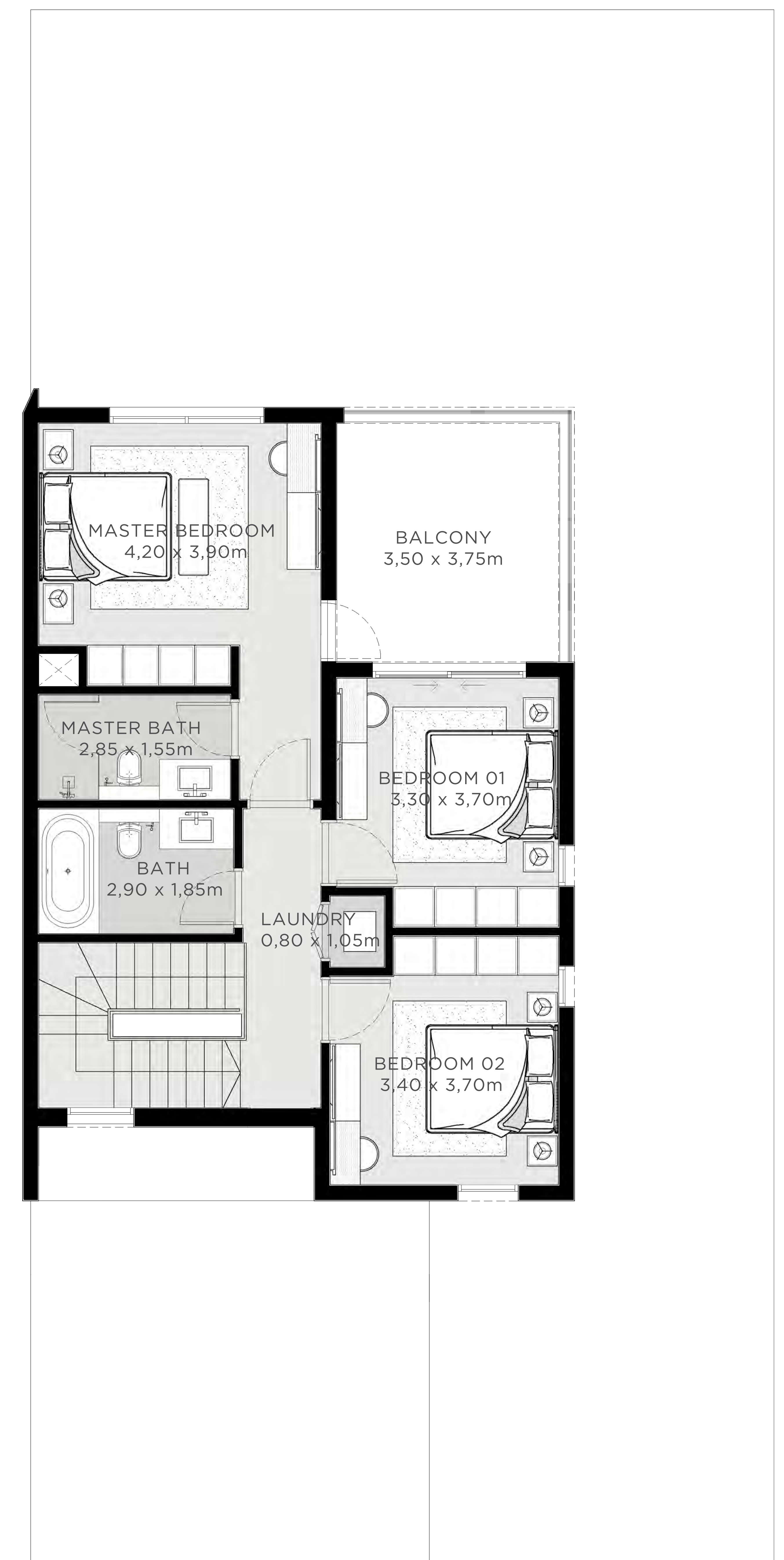

FIRST FLOOR

FLOOR PLAN 1. All dimensions are in imperial and metric, and measured from finish to finish excluding construction tolerances. 2. All materials, dimensions, and drawings are approximate only. 3. Information is subject to change without notice, at developer's absolute discretion. 4. Actual area may vary from the stated area. 5. Drawings not to scale. 6. All images used are for illustrative purposes only and do not represent the actual size, features, specifications, fittings, and furnishings. 7. The developer reserves the right to make revisions / alterations, at it's absolute discretion, without any liability whatsoever.